

# SF Sensor Meter User Manual



### Features:

- The upper line red LED display real time,maximum & minimum value,and the lower line green LED display measure unit or alarm value.
- Support 3 alarms output maximum
- Support many kinds of linear signal inputs or temperature sensor signals
- Optional 4-20mA DC transmission output , can modify the transmission range and make calibration.
- RS485 communication and Modbus-RTU protocol
- Power supply 100 ~ 240V AC/DC.
- Isolated DC24V voltage output (30mA).
- Peak value hold function, easy to record the maximum and minimum measurement data
- easy to operate, economical and practical.

KKSF03-A/0-20160311

### 2.Cable caution:

- 1)Please use specified compensation wire in the place of TC input;Please use insulated TC if the measured device is heated metal.
- 2)Please use the cable of lesser resistance in the place of RTD input,and the cable(3 wire) must be no resistance difference,but the total length is within 5m.
- 3)In order to avoid the effect of noise;please put the input signal away from meter cable,power cable,load cable to wiring.
- 4)In order to reduce the power cables and the load power cables on the effect of this product,please use noise filter in the place where easy to effect.You must install it on the grounding of the disk if you use the noise filter,and make the wiring to be shortest between noise filter output side and power connectors.Don't install fuse and switch on the wiring of noise filter output side,otherwise it will reduce the effect of noise filter.
- 5)It takes 5s from input power to output.If there is a place with interlocking actions circuit signal,please use timer relay.
- 6)Please use twisted pair with a shield for analog output line,to ensure the reliability of signal.
- 7)Please use twisted pair with a shield for remote RS485 communication cable,and deal with the shield on the host side earth, otherwise it will reduce the effect of noise filter.
- 8)This product is not the fuse;please set according to rated voltage 250V,rated current 1A if you need;fuse type:relay fuse.
- 9)Please use the suitable screw force and crimp terminal.  
The screw terminal size: M4X8 (with 7.0X7.0 square base)  
Recommended tightening torque: 0.7N.m  
Proper cables: 0.25~1.65mm single cable/multiple core cable
- 10)Please don't put the Crimp terminal or bare wire part contact with adjacent connector.

## I . Model Illustration

SF 8 - 1 R 2 8 B T - C --- C: Version

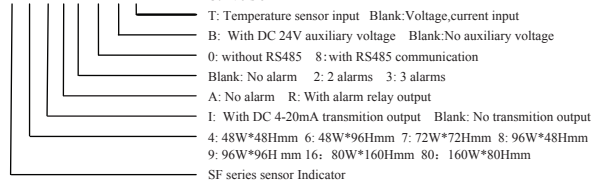

## II . Order Model Information

Model	Signal input	Alarm	Auxiliary voltage	Transmission output	RS485
SF□-A0	mA、V				
SF□-R20B	mA、V	2	•		
SF□-R28B	mA、V	2	•		•
SF□-IR20B	mA、V	2	•	•	
SF□-IR28B	mA、V	2	•	•	•
SF□-A0-T	TC/RTD/mV/RT				
SF□-R20B-T	TC/RTD/mV/RT	2	•		
SF□-R28B-T	TC/RTD/mV/RT	2	•		•
SF□-IR20B-T	TC/RTD/mV/RT	2	•	•	
SF□-IR28B-T	TC/RTD/mV/RT	2	•	•	•

## III . Specification

### 1.Electrical parameters

Sample rate	4 Times/seconds
Relay capacity	AC 250V /3A life of rateD load>100,000 times
Power supply	AC/DC 100 ~ 240V (85-265V)
Power consumption	<6VA
Environment	Indoor , temperature: -5 ~ 50℃ no condensation; Humidity:<85%RH; Altitude<2000m
Storage environment	-10 ~ 60℃,no condensation

The instruction explain instrument settings,connections,name and etc.please read carefully before you use the temperature controller.

## Safety Caution

### ⚠ Warning

- 1) If the fault of the product or abnormal system lead to a serious accident, please set the appropriate circuit protection outside.
- 2) Before the connection completely, please do not power. Otherwise it may result in electric shock, fire, malfunction.
- 3) Do not use the product out of scope of specifications range. Otherwise, it may result in fire, malfunction.
- 4) Do not use in places with flammable and explosive gas.
- 5) Do not touch the site of high voltage power terminal site after power. Otherwise, there is danger of electric shock.
- 6) Do not disassemble, repair and modify this product. Otherwise, it may result in electric shock, fire, malfunction.

### ⚠ Caution

- 1) This product should not be used in a nuclear plant and medical equipment which associated with human life.
- 2) Some time,it will happen radio interference when the product uses in home environment.It should take adequate countermeasures.
- 3) This product has electric shock protection through improved insulation.And when using the product and connecting,it subject to compliance with specifications.
- 4) In order to avoid lightning surge,it should set appropriate surge suppression circuits when the product uses in the environment where the total cable length more than 30 metre.
- 5) The product uses in disk,and avoid to touch the part of high voltage,please take the necessary measure on the final product.
- 6) Please observe the precautions in this manual, otherwise there is risk of causing significant harm or accident.
- 7) Please observe the regulation when wiring.
- 8) To prevent to damage the machine and prevent to machine failure, the product is connected with power lines or large capacity input and output lines and other methods please install proper capacity fuse or other methods of protection circuit.
- 9) Please don't put metal and wire elastic mixed with this product,otherwise it may lead to electric shock, fire, fault.
- 10) Please tighten screw torque according to the rules.If not,it may lead to electric shock and fire.
- 11) In order not to interfere with this products to dissipate heat, please don't plug casing around the cooling vent hole and equipment.
- 12) Please don't knock or rub the panel with rigid thing.
- 13) The readers of this manual should have basic knowledge of electrical,control, computer and communications.
- 14) The illustration, example of data and screen in this manual is convenient to understand,instead of guaranteeing the result of the operation.
- 15) In order to use this product with safety for long-term,regular maintenance is necessary. The life of some parts of the equipments are by some restrictions, but the performance of some will change for using many years.
- 16) Without prior notice, the contents of this manual will be change. We hope these is no any loopholes, if you have questions or objections, please contact us.

### ⚠ Caution of Install & Connection:

#### 1.Installation:

- 1) This product is used in the following environmental standards.  
(IEC61010-1) [Overvoltage category II、class of pollution 2]
- 2) This product is used in the following scope:surrounding environment, temperature, humidity and environmental conditions.  
Temperature: 0~50℃; Humidity: 45~85%RH;Environment condition: Indoor warranty,The altitude is less than 2000m.
- 3) Please avoid using in the following places:  
The place will be dew for changing temperature;with corrosive gases and flammable gas;with vibration and impact;with water, oil, chemicals, smoke and steam facilities with Dust, salt, metal powder,and with clutter interference, static electric and magnetic fields, noise;where has air conditioning or heating of air blowing directly to the site.
- 4) On the occasion of the installation, please consider the following before installing several.  
In order to protect heat saturated, please ensure adequate ventilation space.  
Please consider connections and environment,and ensure that the products below for more than 50mm space  
Please avoid to installed over the machine of the calorific value(Such as heaters, transformer, semiconductor operations, the bulk resistance).  
When the surrounding is more than 50℃, please using the force fan or cooling fans.But don't let cold air blowing directly to the product.  
In order to improve the anti - interference performance and security, please try to stay away from high pressure machines, power machines to install.  
Don't install on the same plate with high pressure machine and the product.  
The distance should be more than 200mm between the product and power line.

1

Current output	DC 4 ~ 20mA load < 500Ω
Communication port	RS485 port Modbus-RTU protocol
Insulation impedance	Input,output,power cabinet>20MΩ
ESD	IEC/EN61000-4-2 Contact ±4KV /Air ±8KV perf.Criteria B
Pulse triap anti-interference	IEC/EN61000-4-4 ±2KV perf.Criteria B
Lightning surge	IEC/EN61000-4-5 ±2KV perf.Criteria B
Frequency drop	IEC/EN61000-4-29 0% ~ 70% perf.Criteria B
Dielectric strength	Signal input & output & power 1500VAC 1min. below 60V Low voltage circuit between DC500V,1min
Total weight	About 400g
Material of case	The case and panel frame PC/ABS (Flame Class UL94V-0)
Material of panel sticker	PET(F150/F200)
Power-off data protection	10 years, times of writing:100w times
Protection level of panel	IP65(IEC60529)
Safety Standard	IEC61010-1 Overvoltage category II

### 2.Signal parameters

Input	Symbol	Range	ratio	Accuracy	Input impedance/auxiliary current	Code
K	℄	-50 ~ 1200℃	1℃	0.5%FS±3digits	>500KΩ	0
K.0	℄.0	-50.0 ~ 500.0℃	0.1℃	0.5%FS±3digits	>500KΩ	1
J	℄	0 ~ 1200℃	1℃	0.5%FS±3digits	>500KΩ	2
E	℄	0 ~ 850℃	1℃	0.5%FS±3digits	>500KΩ	3
T	℄	-50 ~ 400℃	1℃	0.5%FS±2℃	>500KΩ	4
N	℄	-50 ~ 1200℃	1℃	0.5%FS±3digits	>500KΩ	5
B	℄	600 ~ 1800℃	1℃	0.5%FS±2℃	>500KΩ	6
R	℄	0 ~ 1600℃	1℃	0.5%FS±2℃	>500KΩ	7
S	℄	-10 ~ 1600℃	1℃	0.5%FS±2℃	>500KΩ	8
PT100	℄	-200.0 ~ 600.0℃	0.1℃	0.5%FS±3digits	0.2mA	9
CU50	℄	-50.0 ~ 150.0℃	0.1℃	0.5%FS±3℃	0.2mA	10
CU100	℄	-50.0 ~ 150.0℃	0.1℃	0.5%FS±1℃	0.2mA	11
0 ~ 50mV	℄	-1999 ~ 9999	0.01%FS	0.5%FS±3digits	>500KΩ	12
0 ~ 400Ω	℄	-1999 ~ 9999	0.01%FS	0.5%FS±3digits	0.2mA	13
0 ~ 10V	℄	-1999 ~ 9999	0.01%FS	0.5%FS±3digits	>500KΩ	14
4 ~ 20mA	℄	-1999 ~ 9999	0.01%FS	0.5%FS±3digits	100Ω	15
0 ~ 5V	℄	-1999 ~ 9999	0.02%FS	1%FS±3digits	>500KΩ	16
1 ~ 5V	℄	-1999 ~ 9999	0.02%FS	1%FS±3digits	>500KΩ	17
0 ~ 20mA	℄	-1999 ~ 9999	0.01%FS	0.5%FS±3digits	100Ω	18

### 3. Isolation diagram

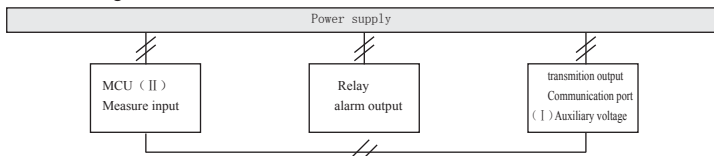

“//”: Isolation  
 Note: when the auxiliary voltage used for power supply of external sensor and if the sensor is non-isolated, then it is not isolated between (I) and (II)

### IV. Name of universal panel

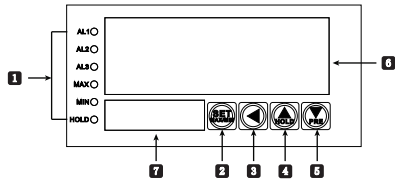

No.	Symbol	Name	Function
1	AL1	Alarm 1 indicator light	1st alarm output indication, alarm output with lighting, no alarm output without lighting
	AL2	Alarm 2 indicator light	2nd alarm output indication, alarm output with light, no alarm output without light
	AL3	Alarm 3 indicator light	3rd alarm output indication, alarm output with light, no alarm output without light
	MAX	Light of max value	when the MAX value indicator lighting, PV display the maximum value
	MIN	Light of min value	when the MIN value indicator lighting, PV display minimum value.
	HOLD	Light of hold value	when HOLD value indicator lighting, PV display hold value.
	2	SET	SET key
3	Shift	Shift key	Parameters modify activating, modify bit moves to left
4	▲	Add/hold key	Increase the flashing bit value, hold measurement instantaneous value
5	▼	Reduce/reverse key	Reduce the flashing value, browse menu in backward sequence.
6	PV	Upper display window	Display current/max/min value and parameter symbol, error remind
7	SV	Lower display window	Display measure unit, parameter and alarm value

### V. Unit symbol comparison

No.	Symbol	Unit	No.	Symbol	Unit	No.	Symbol	Unit
0	-	no	11	N	N	22	KV	KV
1	M	M	12	W	W	23	mA	mA
2	cm	cm	13	KW	KW	24	A	A
3	mm	mm	14	RPM	RPM	25	KA	KA
4	kg	kg	15	RPS	RPS	26	Ω	Ω
5	g	g	16	MPM	MPM	27	KΩ	KΩ
6	mg	mg	17	MPS	MPS	28	°C	°C
7	Mpa	Mpa	18	Hz	Hz	29	°F	°F
8	pa	pa	19	KHz	KHz	30	K	K
9	ba	ba	20	mV	mV			
10	mbar	mbar	21	V	V			

4

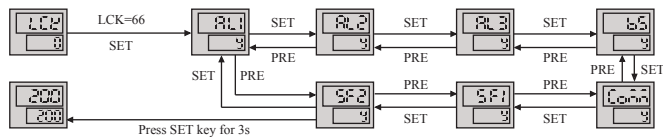

Menu shield function, function symbol and its according parameters are as below:

**AL1:** AD1, AL1, HY1, AE1, DL1A, DL1B;  
**AL2:** AD2, AL2, HY2, AE2, DL2A, DL2B;  
**AL3:** AD3, AL3, HY3, AE3, DL3A, DL3B;  
**BS:** BRL, BRH, OLL, OLLH, TEST;  
**COMM:** BAUD, ADDR, DTC;  
**SF1:** CAS, CAK, SORT;  
**SF2:** DREF, STEP, CJC, RLMR;

When it display one function symbol, lower line will display “Y” or “N” (Y means start the function; N means stop the function)  
 For example: if the meter have no first alarm, please set the AL1 to “N” and then exit menu.  
 Then the menu and submenu will not display AD1, AL1, HY1, AE1, DL1A, DL1B and the alarm function stop to work.

- 1) In the normal measurement mode and when the MME=Y, press (▲) key can shift display of max/min/current value in cycle.
- 2) Enter MME menu, and set it as displays “Y”, press (▲) key to restart to record max/min value.
- 3) In the normal measurement mode, short press (▲) key can lock current display value, and press again to unlock.
- 4) Before using CAS, CAK calibration function, long press (▲) (▼), (make sure PSB=0)

#### 2. Directions of menu

Symbol	Menu name	Directions	Setting range	Factory
1	MME	Max/min value starting record function. Y: start, N: close	0 (N) 1 (Y)	N
2	AD1	Optional 4 types alarms : 0: alarm close; L: low limit alarm; H: high limit alarm; Int: interval alarm; Out: outside the interval alarm	0, L, H, Int, Out	L
3	AL1	1st alarm setting value	FL-FH	200
4	AH1	1st alarm interval high limit value	FL-FH	1000
5	HY1	1st alarm backlash value	0-1000	1
6	AD2	Optional 4 types alarm, set as 0, alarm close	0, L, H, Int, Out	H
7	AL2	2nd alarm setting value	FL-FH	600
8	AH2	2nd alarm interval high limit value	FL-FH	1000
9	HY2	2nd alarm backlash value	0-1000	1
10	AD3	Optional 4 types alarm, set as 0, alarm close	0, L, H, Int, Out	H
11	AL3	3rd alarm setting value	FL-FH	800
12	AH3	3rd alarm interval high limit value	FL-FH	1000
13	HY3	3rd alarm backlash value	0-1000	1
14	LDSP	lower line led display choice : no display, measuring unit, 1st/2nd/3rd alarm value.	Non, Unit, AL1, AL2, AL3	Unit
15	FT	filter coefficient of digital filters. The higher of value, the larger the filter effect.	1-255	10
16	DREF	Display refresh cycle, unit:s	0-5	0
17	DP	decimal point setting for linear signal	0-3	0
18	INP	Input signal types	Refer signal sheet page 3	0-10V/K
19	FL	measure range low limit, setting value must be less than range high limit	Refer signal sheet page 3	0/-50

6

### VI. Operation and Menu Direction

#### 1. Operation of normal menu and shielding menu

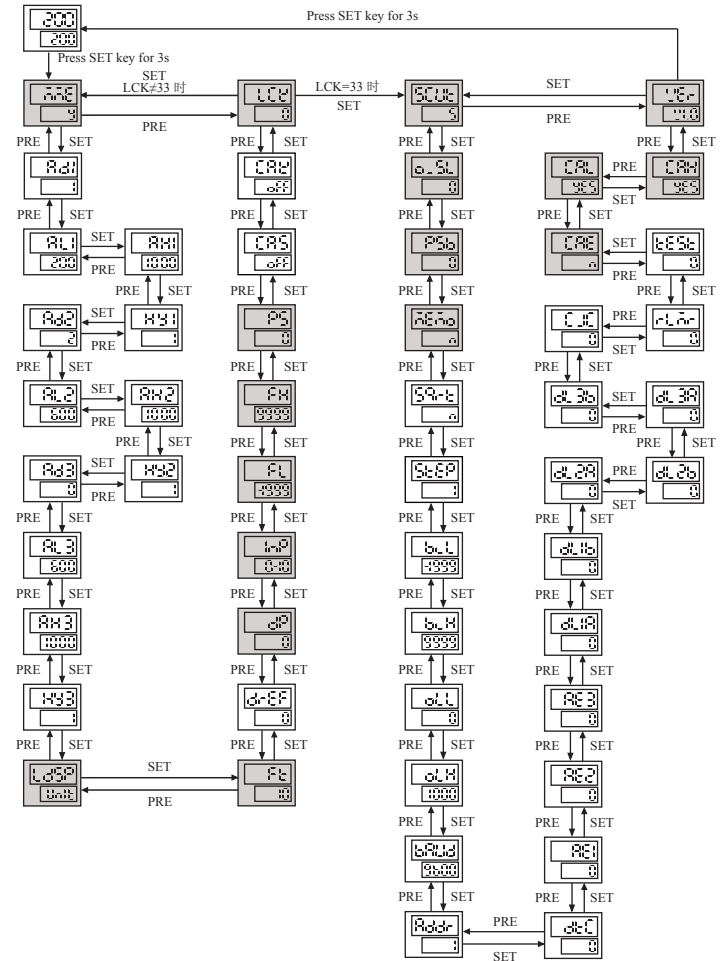

5

20	FH	Measured high limit, setting value must larger than measured low limit	Refer to input signal label	1000/1200
21	PS	Amend value, display value=actual measured value+ amend value	-1999-9999	0
22	CAS	Displayed value of low limit input signal. set corresponding value of low limit input, press (▼) to decrease CAS value. when CAS= OFF, this function is disabled.	OFF, FL-FH	OFF
23	CAK	Displayed value of high limit input signal. Set corresponding value of high limit input, press (▲) to decrease CAK value, when CAK= OFF, this function is disabled.	OFF, FL-FH	OFF
24	LCK	Password, LCK=01, unit lock; LCK=10, menu lock; LCK=11, unit&menu lock; LCK=33, it can enter class 2 menu; LCK=5555, reset to factory setting.	0-9999	0
25	SCUT	Small signal elimination function, please refer to description of o_SL	-1999-9999	5
26	o_SL	Display mode choice. o_SL=0, no function. o_SL=1, measured value < FL, display FL value; measured value > FH, display FH value. o_SL=2, measured value < SCUT/FL, display FL value; measured value > FH, display FH value. o_SL=3, measured value < SCUT, display the smaller value of FL&SCUT; if measured value > FH, display FH value.	0-3	0
27	PSb	Zero function, long press (▲) (▼), display will show zero. And then zero value is stored in PSb. If you want to reset the value, long press (▲) (▼) or set PSb as 0. (Temperature input signal without this function)	-1999-9999	0
28	MEMO	Max/min value power failure protection. Y: open; N: Close	0 (N) 1 (Y)	N
29	SQRT	linear signal Square root	0 (N) 1 (Y)	N
30	STEP	Display jumping interval	1-10	1
31	BRL	transmission output low limit	FL-FH	FL
32	BRH	transmission output high limit	FL-FH	FH
33	OLL	Adjust transmission output low limit OLL=(preset transmission low limit - actual transmission low limit)/ actual transmission range*1000	-500-1000	0
34	OLH	Adjust transmission output high limit OLH=(preset transmission high limit - actual transmission high limit)/ actual transmission range *1000+1000	0-1050	1000
35	BAUD	Communication baud rate	4.8K, 9.6K, 19.2K	9.6K
36	ADDR	Meter communication address	1-255	1
37	DTC	Communication delay time	Refer Communication protocol remark	0
38	AE1	AL1 extensions	0-11	0
39	AE2	AL2 extensions	0-11	0
40	AE3	AL3 extensions	0-11	0
41	DL1A	start the function AL1 delay(unit:s)	0-999.9	0.0
42	DL1B	close the function of AL1 delay(unit:s)	0-999.9	0.0
43	DL2A	start the function of AL2 delay (unit:s)	0-999.9	0.0
44	DL2B	close the function of AL2 delay (unit:s)	0-999.9	0.0
45	DL3A	start the function of AL3 delay(unit:s)	0-999.9	0.0
46	DL3B	close the function of AL3 delay(unit:s)	0-999.9	0.0

7

47	CJC	Thermocouple low temperature compensation mode : auto-compensation, close compensation, input compensation temperature by manual	-1 (Auto), 0 (Off), 1-50	Auto
48	RLMR	linear resistance value, can use it when linear resistance is large (Unit: mΩ)	0-9999	0
49	TEST	Simulating input test, used to test output function	FL-FH	OFF
50	CAE	User calibration function, this parameter is only for linear signal; Y: use user calibration parameters; N: No user calibration function	0 (N), 1 (Y)	N
51	CAL	Operation of user calibrating low limit input, after adding the low limit signal to signal input terminal, flash display YES, press "OK" to confirm. When it displays OK, it finishing calibrate low limit input signal.	YES/OK	YES
52	CAH	Operation of user calibrating high limit input, after adding the high limit signal to signal input terminal, flash display YES, press "OK" to confirm. When it displays OK, it finishing calibrate high limit input signal.	YES/OK	YES
53	VER	Display the software version;	Unable to set	V1.0

### 1. High & low limit display setting function

Example: use electronic ruler or others to measure , if want position 5mm display 500, position 6mm display 600, firstly enter into function shield menu, make SF1=Y (open the function of CAS, CAK parameter), then enter menu to set CAS=500 at 5mm position, and set CAK=600 at position 6mm, exit to the measure measure interface after finishing setting.

### 2. Linear signal self-calibration function

- Set INP type, and make sure that it is one of the linear signals.
  - The input signal should input to correct input channel.
  - Enter low limit calibration menu CAL, press "OK" to flash "YES"; and adjust the input signal to the minimum value.
  - When "YES" flashing, and the minimum value of input signal is input into the meter; press "OK" to confirm and save calibration value.
  - After the low limit is calibrated, enter high limit calibration menu CAH, and flash "YES" in the same way.
  - Adjust the input signal to the maximum value, and input it into the meter. And when "YES" flashing, press "OK" to confirm and save calibration value of high limit.
  - After calibration, enter CAE to change "N" into "Y" to enable calibration; otherwise, it will use the default calibration value.
  - The calibrated high limit input value of linear signal should not beyond the ±10% of the standard signal
  - After the calibration, if the result is not satisfactory, it can be recalibrated.
- ### 3. Transmision range calibration function
- Example: actual high limit is 20.4mA, low limit is 3.97mA. To calibrate the transmision range through modification of OLL, OLH.  
 $OLL = (\text{Preset transmit low limit} - \text{actual transmit low limit}) / \text{actual transmit range} * 1000 = (4.0 - 3.97) / (20.4 - 3.97) * 1000 = 2$   
 $OLH = (\text{Preset transmit high limit} - \text{actual transmit high limit}) / \text{actual transmit range} * 1000 + 1000 = (20.0 - 20.4) / (20.4 - 3.97) * 1000 + 1000 = 976$

## VII . Alarm parameters and output logic diagram

Alarm code	Type	Logic diagram
H	High limit absolute value alarm	
L	Low limit absolute value alarm	
int	Interval alarm	
dev	Deviation alarm	

8

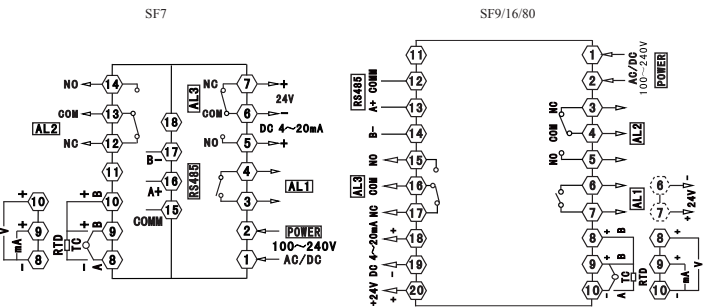

Note: If there is any change, please subject to the drawing on the meter

## X I . Methods of simple fault

Display	Methods
HHHH/LLLL	Checks whether the input disconnection and whether normal of FH value, FL value, working environment temperature and whether input signal is selected correctly.

## X II .Communication proctool

Meter adopt Modbus RTU communication protocol, RS485 half duplex communication Read function code:0x03, write function code 0x06 or 0x10. Adopts 16 digit CRC check, the meter does not return for error check.

Data frame format:

Start bit	Data bit	Stop bit	Check bit
1	8	1	No

Abnormal communication processing:

When abnormal response , put 1 on the highest bit of function code. For example: when host request function code is 0x03, slave response function code should be 0x83.

Error code:

0x02---Illegal address: the register address designated by host beyond the address range of meter.

Communication cycle:

Communication cycle is the time from host request to slave response data . ie: communication cycle= time of request data sending +slave preparation time + response delay time + response return time.

Eg: 9600 Baud rate: communication cycle of single measured data ≥ 250ms.

## Alarm extension function table

AE1/AE2/AE3 value	Alarm handling mode when display is over limit	inhibits alarms or not when power on
0	Status maintained	Do not inhibit (As long as it meets the requirement of alarm, alarm output)
1	Forced alarm output	
2	Forced alarm close	
3	Status maintained	Inhibit (Forced alarm close when power on; alarm does not output until PV meet alarm condition)
4	Forced alarm output	
5	Forced alarm close	

## IX . Dimension

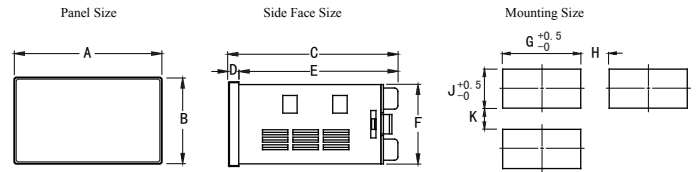

Model	A	B	C	D	E	F	G	H(Min)	J	K(Min)
3.(72*36)	72	36	70.5	6.5	64	32	68	25	33	25
4.(48*48)	48	48	101	10	91	45	45.5	25	45.5	25
6.(96*48)	48	96	100	6	94	91	45.5	25	91.5	25
7.(72*72)	72	72	100	10	90	67.5	68	25	68	25
8.(48*96)	96	48	100	6	94	45	91.5	25	45.5	25
9.(96*96)	96	96	100	10	91	90.5	91	25	91	25
80.(80*160)	160	80	102	10	92	76	154	30	76.5	30
16.(160*80)	80	160	102	10	92	153.5	76.5	30	154	30

## X . Connection drawing

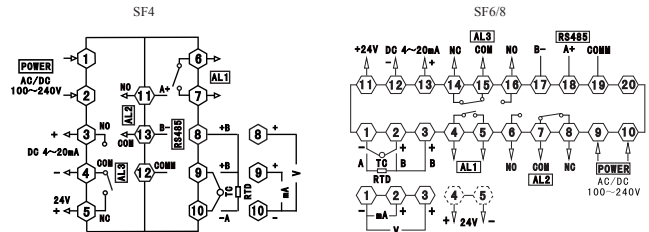

9

### 1 Read register (0x03)

For example: Host reads integer AL1 (AL1=200)

The address code of AL1 is 0x3201, because AL1 is integer (2 byte), seizes 1 data register. The memory code of decimal integer 200 is 0x00C8.

Note: It should read DP value or confirm DP menu value first to ensure the decimal point position when reading data, and conversely the reading data to get the actual value. On the contrary, it should conversely the data to corresponding ratio first before writing the data into meter.

Host request (Read multi-register)							
1	2	3	4	5	6	7	8
Meter ADD	Function code	Start ADD High bit	Start ADD Low bit	Data byte length high bit	Data byte length low bit	CRC code low bit	CRC code high bit
0x01	0x03	0x32	0x01	0x00	0x01	0xDB	0x72

Slave normal answer (Read multi-register)						
1	2	3	4	5	6	7
Meter ADD	Function code	Data byte number	Data high bit	Data low bit	CRC code low bit	CRC code high bit
0x01	0x03	0x02	0x00	0xC8	0xB9	0xD2

Address error abnormal answer: (For example, host request address is 0x2101)

Slave error answer				
1	2	3	4	5
Meter ADD	Function code	Error code	CRC code low bit	CRC code high bit
0x01	0x83	0x02	0xC0	0xF1

### 2 Write multi-register (0x06)

For example: Host writes AL1 (First alarm set value 100)

The address code of AL1 is 0x3201, because AL1 is integer (2 byte), seizes 1 data register. The hexadecimal memory code of decimal integer 100 is 0x0064.

Host request (Write single-register)							
1	2	3	4	5	6	7	8
Meter ADD	Function code	Data ADD High bit	Data ADD Low bit	Data High bit	Data Low bit	CRC code low bit	CRC code high bit
0x01	0x06	0x32	0x01	0x00	0x64	0xD7	0x59

Slave normal answer (Write single-register)							
1	2	3	4	5	6	7	8
Meter ADD	Function code	Data ADD High bit	Data ADD Low bit	Data High bit	Data Low bit	CRC code low bit	CRC code high bit
0x01	0x06	0x32	0x01	0x00	0x64	0xD7	0x59

