

EW9T Intelligent Power Meter Operation Manual

2016 Version V. 1

Operation Manual

Please refer to the manual during install and operation

>>> OPEN

Instructions

User Instructions

Please read the manual before using the products :

1. During operation, note the waterproof ,anti-sunshine and anti-crash
2. Normal install and test instruments are as blow:
Slotted screwdriver and digital multi-meter
3. To ensure the accuracy of the meter. Please input the suitable voltage and current signal. If the input voltage and current is less than range , can direct input the voltage and current. If beyond the range , please input via PT and CT.
4. PT or CT accuracy will effect the meter accuracy. The secondary output should connect thick and short low impedance conductor to reduce interference.

- Note:We keep the authority to modify and update the product. And we will not inform when make updatation for the manual.

Content

Content

- User Instructions.....01
- Content02
- Chapter 1 Product description.....04
- Chapter 2 Main Technical Datasheet05
- Chapter 3 Panel Illustration.....06
- Chapter 4 Page Shift Illustration.....12
- Chapter 5 Page Operation flowchart15
- Chapter 6 Menu Operation&Illustration35
- Chapter 7 Communication&Protocol41



EW9T Product Photo

Mounting Dimension :

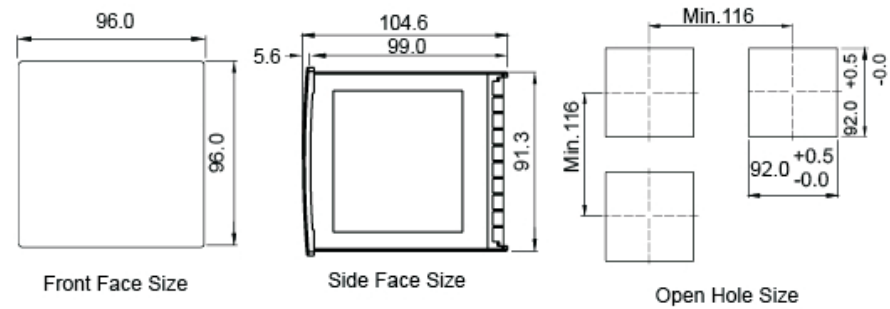

Wire Connection

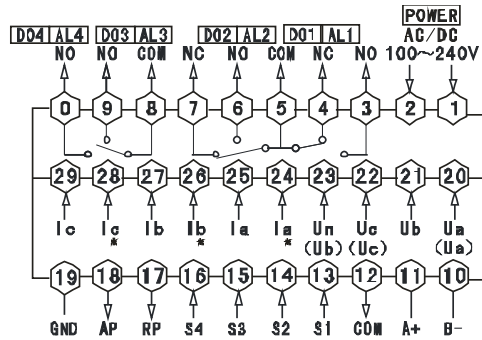

Note: Voltage input terminals, bracket terminals shows 3 phase 3 wire connection.
Current * means current input terminals, all input and output must be coincident

Model 1: (3pcs CT) 3 phase 4 wire working mode

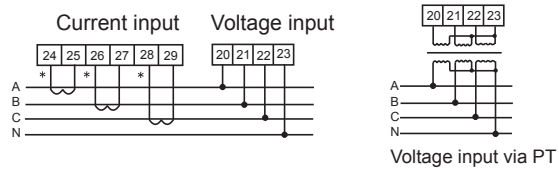

Current input via CT Voltage direct input

Model 2: (2pcs CT) 3 phase 3 wire working mode

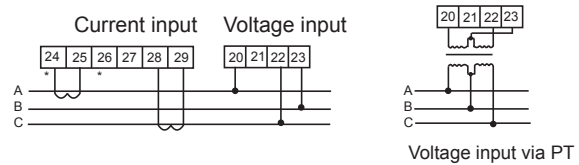

Current input via CT Voltage direct input

Chapter 1

Product Description

Product Description

Main Technical Parameters

- Measure Parameters: 3 phase voltage , current , active power , reactive power ,power factor, apparent power, Kwh , frequency etc.
- True effective value measurement . Accuracy is 0.5%F.S, when frequency is 0-420Hz , can meet military requirement.
- Optional 4 loops switch input and switch output ,input and output are fully isolated. With remote communication and control function.
- With programmable transmit output function for the voltage , current, active power , reactive power, frequency , power factor.
- Optional 2 loops Rs485 communication, Modbus RTU or DLT645 protocol.
- 2 loops energy pulse output.
- Maximum demand statistics function , include current, active power , reactive power, apparent power .(15 minutes one cycle)
- With harmonics analysis function .
- Power failure memory function of Kwh and KvarH .
- With bidirectional active power and reactive power record function.
- Programmable 8 period and 4 different tariff rate function.
- With 32 events record function , can record the power on event , clear Kwh event , modify parameter event and alarm event etc.
- 320*240 TFT color 320×240 LCD display.

This meter can directly or indirectly measure 3 phase 3 wire and 3 phase 4 wire net voltage , current , active power, reactive power, power factor etc.It can be widely applied to control system, SCADA system and energy management system,transformer substation automation, distributing net automation, electric power monitor, industrial automation, intelligent construction, switch cabnit . It is easy to install and maintain , simple connection and programmable setting parameters.

Chapter 2



 Main
 Technical
 Parameters

Technical Parameter

Wire connection	3 phase 3 wire , 3 phase 4 wire
Reference voltage	3*220/380V
Voltage overload	Continuous: 1.2 times
Power Consumption	<1VA (Each phase)
Voltage Impedance	≥300KΩ
Voltage Accuracy	RMS Measurement, Accuracy 0.2%F.S
Rated Current	5A (input via CT)
Current Overload	Continuous:1.2 times , Instantaneous:10 times/10S
Current Consumption	<0.4VA (Each phase)
Current Impedance	<20mΩ
Current Accuracy	RMS measurement, Accuracy:0.2%F.S
Reference frequency	45-60Hz,Accuracy:0.1Hz
Power Accuracy	Active power, reactive power,apparent power 0.5%F.S
Energy Accuracy	Active energy accuracy: 1S/0.5S,
	Reactive energy accuracy: 1S/0.5S,
Display	TFT color multi-language display
Power supply	AC/DC 100~240V (Limit range 85~265V)
Power Consumption	≤20VA
Output digit port	Rs485, Modbus RTU
Pulse output	2 loops energy pulse output ,pulse constant 9000
Switch input	4 loops switch input(dry contact)

Technical Parameter

Alarm output	2 loops switch output,AC250V/3A or DC30V/5A
Analog output	1loop 4-20mA transmit output, load≤400Ω
Work environment	Temperature :-10-55℃ , Humidity<85%RH
Store Environment	-20~75℃
Isolation & Puncture	Input VS power supply , input VS ouput≥AC1600V, Power VS transmit
	output, RS485 port, DI port, Pulse output port ≥DC2000V
Insulation	Input,output,power VS Cover>5MΩ
Dimension	96W×96H×100L
Weight	0.6kg
Reference standard	GB/T 17215.301

Measure Range

Name	Measure Range	Note
3 phase voltage	0~220KV	
3 phase current	0~5000A	
3 phase active power	-2000~2000MW	
3 phase reactive power	-2000~2000MW	
3 phase apparent power	0~2000MW	Note
3 phase power factor	-1000~1000	
Kwh	0~1000000000KWh	
Frequency	40~65Hz	

Note: When apparent power≥2000MW, it will remind beyond limit.

Chapter 3

Panel
Illustration

The screenshot shows a panel display with a data table and control buttons. The data table is as follows:

Para	U	I	PF	P	Q	S
Unit	V	A		kW	kvar	kVA
L1	0.0	0.000	0.000	0.000	0.000	0.000
L2	0.0	0.000	0.000	0.000	0.000	0.000
L3	0.0	0.000	0.000	0.000	0.000	0.000
Tot						

Below the table, there are two rows of data:





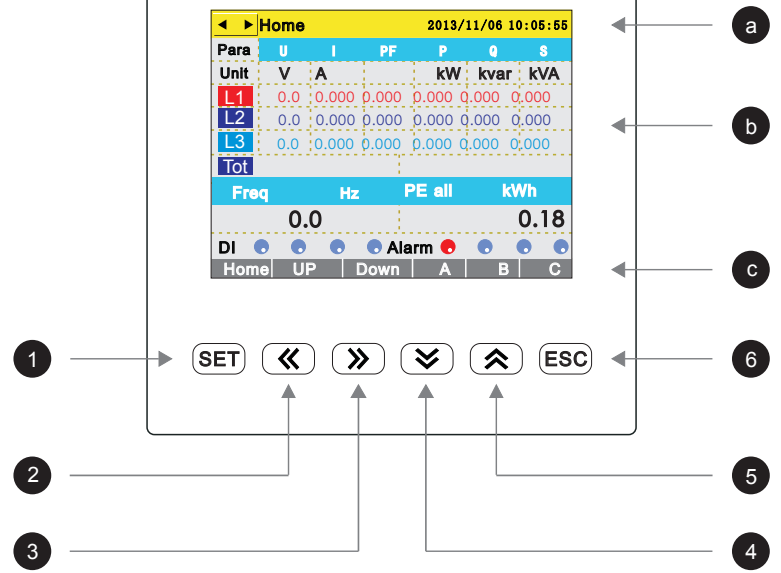

Freq	Hz	PE all	kWh
	0.0		0.18

At the bottom, there are control buttons: Home, UP, Down, Alarm (with a red dot), A, B, C. Below the screen are six physical buttons: SET, left arrow, right arrow, down arrow, up arrow, and ESC.



Panel Illustration

Panel Illustration

No	Symbol	Name	Function
1		Enter setting interface key, Confirm key, Home page key	Enter setting interface: Press SET more than 3 seconds , enter into setting interface. Confirm key: confirm parameter modification. Home page key: Back up to home page in measure status.
2		Cursor left shift key, Up page	Cursor left shift key: In set interface, press the key to shift the cursor to left or to upside. Up page: Go to next page in measuring status.
3		Cursor right shift key, Down page	Cursor right shift key: In set interface, press the key to shift cursor to right or to downside. Down page: Go to previous page in measuring page.
4		Cursor down shift key , Parameter modify & decrease key	Parameter modify: Decrease parameter value when modifying parameter. A Phase measure value: Display A phase measure value.
5		Cursor up shift key , Parameter modify & increase key	Parameter modify: Increase parameter value when modifying parameter. B Phase measure value: Display B phase measure value.
6		Exit/Return Key	Exit: Exit from the current interface in set interface. C phase measure value: Display C phase measure value.

LCD display and interface formation

The meter adopt 320*240 color LCD display , interface is formed by status display part, data display part and operation indicate part.

- a Status display part:
Display date and event, present interface name etc.
- b Data display part
Display measure and calculation data interface.
- c Indicate Operation part:
Indicate present interface key action .

Run Status

After power on ,meter come to run status directly. In running status , it display test voltage , current value and total Kwh value.

Set Interface

All the functions in setting modes.

Chapter 4

Page Shift Illustration

Check Measuring value and working status indication:

1. In measure status , press 《/》 to shift display of home page , phase voltage, line voltage, line current, active power , reactive power , apparent power, power factor, all phase parameter , present Kwh , history Kwh , total harmonic , tariff rate etc.

2. In measure status , press SET to return the home page from any interface.

3. In measure status , the last line of display indicate the key function .
Eg : A phase , means thatwhen press the key , it displays A phase parameters.

4. In measure status ,long press SET key to enter setting interface. (If have set the password , need to input the correct password to get to the setting page.)

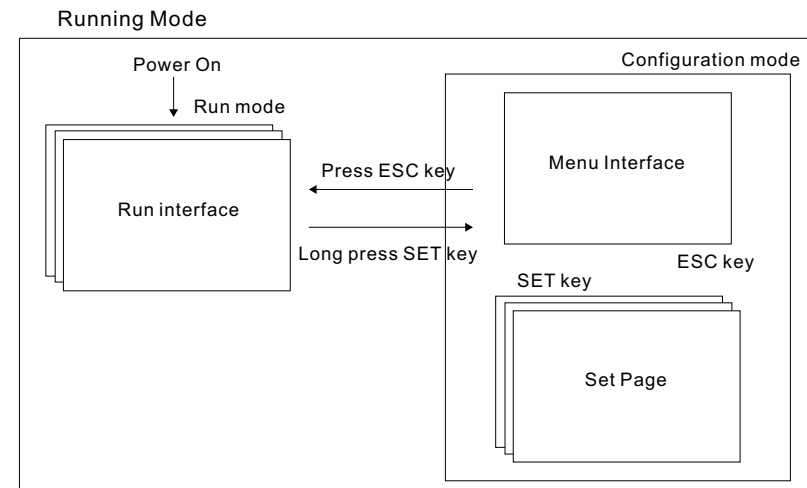

Chapter 5

Page Operation
Flowchart

1. Measure interface key operation flowchart:

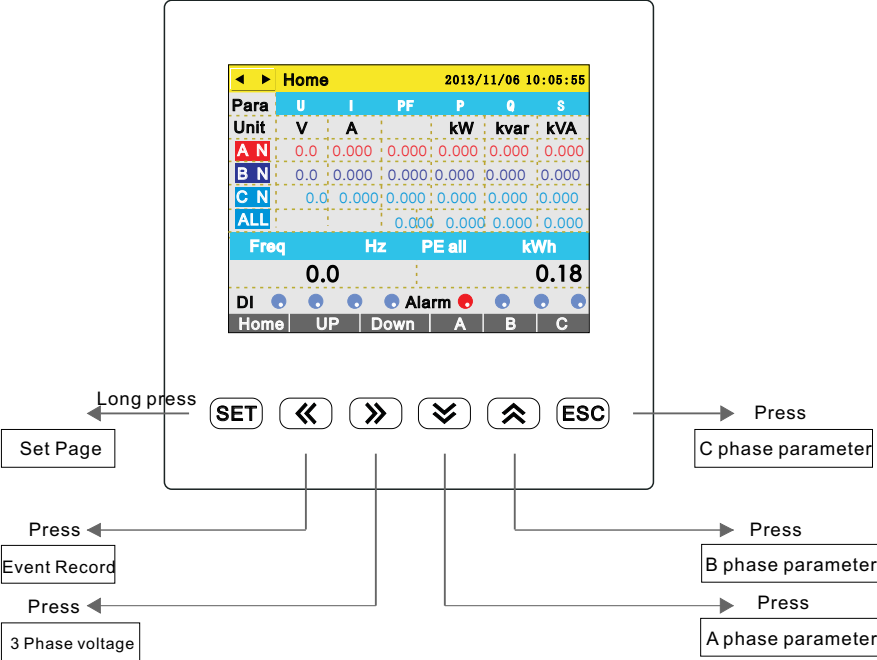

Page Operation Flowchart

Page Operation Flowchart

2.Measure Interface Operation

1 Home page: Display Comprehensive parameters

Home 2013/11/06 10:05:55						
Para	U	I	PF	P	Q	S
Unit	V	A		kW	kvar	kVA
L1	0.0	0.000	0.000	0.000	0.000	0.000
L2	0.0	0.000	0.000	0.000	0.000	0.000
L3	0.0	0.000	0.000	0.000	0.000	0.000
Tot			0.000	0.000	0.000	0.000
Freq		Hz	PE all		kWh	
		0.0			0.18	
DI	<input type="radio"/>	<input type="radio"/>	<input type="radio"/>	<input type="radio"/>	Alarm <input checked="" type="radio"/>	<input type="radio"/>
HOME	UP	DOWN	A	B	C	

Press » to enter next page

2 3 Phase Voltage (Phase voltage)

3 PH Voltage 2013/11/06 10:17:15	
0.0	v
0.0	v
0.0	v
HOME	UP DOWN A B C

Press » to enter next page

3 3 Phase Line Voltage

3L Voltage 2013/11/06 10:18:01	
0.0	v
0.0	v
0.0	v
HOME	UP DOWN A B C

Press » to enter into next page

4 3 Phase Current

3PH Current 2013/09/11 10:18:23	
0.000	A
0.000	A
0.000	A
HOME	UP DOWN A B C

Press » to enter into next page

Page Operation Flowchart

5 3 Phase Active Power:



Press » to enter into next page

6 3 Phase Reactive Power:



Press » to enter into next page

Page Operation Flowchart

7 3 Phase Apparent Power

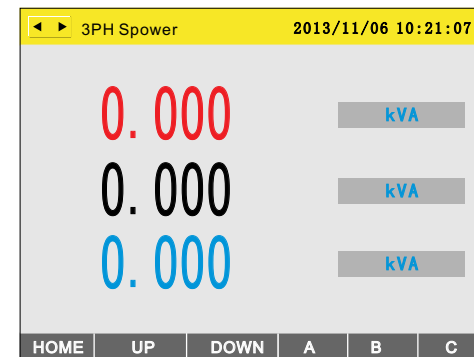

Press » to enter into next page

8 3 Phase Power Factor:

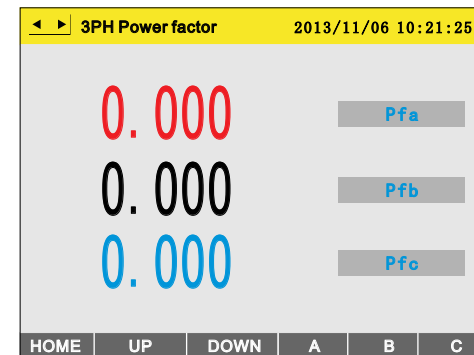

Press » to enter into next page

Page Operation Flowchart

9 Total Power

Total Power		2013/09/11 10:42:13	
Peum	kW	Qsum	Kvar
0.000		0.000	
Saum	kVA	Pfeum	Pf
0.000		0.000	
Voltage Unbalance	%	Current Unbalance	%
0.0		0.0	

Press >> to enter next page

10 Total Energy :

Total Energy		2013/09/11 10:42:13	
Sum	Kwh		0.18
Forward	kWh		0.18
Backword	kWh		0.00
Forward	Kvarh		0.00
Backward	Kvarh		0.00

Press >> to enter next page

Page Operation Flowchart

11 History Energy

History Energy		2013/09/11 10:42:13	
Last I	kWh		10.74
Last II	kWh		0.00
Last III	kWh		0.00
Last IV	kWh		0.00
Last V	kWh		0.00

Press >> to enter next page

12 Total Harmonic Distortion

THD		2013/09/11 10:42:13	
THD Ua	%	THD Ia	%
0.0		0.0	
THD Ub	%	THD Ib	%
0.0		0.0	
THD Uc	%	THD Ic	%
0.0		0.0	

Press >> to enter next page

Page Operation Flowchart

Page Operation Flowchart

13 Demand Statistics

Demand		2013/09/11 10:42:13	
Mode	Record	Action Time	
I D MD	0.000 A	2013/11/06 10:50:00	
I D MD MX	0.000 A	2012/01/01 00:00:00	
P D MD	0.000 kW	2013/11/06 10:50:00	
P D MD MX	0.000 kW	2012/01/01 00:00:00	
Q D MD	0.000 kvar	2013/11/06 10:50:00	
Q D MD MX	0.000 kvar	2012/01/01 00:00:00	
S D MD	0.000 kVA	2013/11/06 10:50:00	
S D MD MX	0.000 kVA	2012/01/01 00:00:00	
HOME	UP	DOWN	A B C

Press >> to enter next page

14 Multi-tariff Rate (total)

Tariff(Totatal)		2013/09/11 10:42:13	
Tariff	This Mon	Last Mon	Last II Mon
Tine	0.00	0.00	0.00
Peak	0.00	0.00	0.00
Flat	0.00	0.00	0.00
Vale	0.00	0.00	0.00
Total	0.00	0.00	0.00
Total Tariff Energy			
Tine	0.00	Peak	0.00
Flat	0.00	Vale	0.00
HOME	UP	DOWN	A B C

Press >> to enter next page

15 Multi-tariff rate (this month)

Tariff(This Month)		2013/09/11 10:42:13	
Tine	Kwh	0.00	
Peak	kwh	0.00	
Flat	Kwh	0.00	
Vale	Kwh	0.00	
Total	Kwh	0.00	
HOME	UP	DOWN	A B C

Press >> to enter next page

16 Multi-tariff rate (Last Month)

Tariff(Last Month)		2013/09/11 10:42:13	
Tine	Kwh	0.00	
Peak	kwh	0.00	
Flat	Kwh	0.00	
Vale	Kwh	0.00	
Total	Kwh	0.00	
HOME	UP	DOWN	A B C

Press >> to enter next page

Page Operation Flowchart

17 Multi-tariff Rate(the moth before last month)

Tariff(Last 11 Mon)		2013/09/11 10:42:13
Tine	kwh	0.00
Peak	kWh	0.00
Flat	kWh	0.00
Vale	kWh	0.00
Total	kWh	0.00

HOME UP DOWN A B C

Press >> to enter next page

18 Event Record page

Event Record 1			2013/09/11 10:42:13
NO.	Comment	Action Time	
1	Clear Egy	2013/10/31	16:34:47
2	Clear Demand	2013/10/31	16:34:50
3	Modify Para	2013/10/31	16:34:51
4	Power On	2013/11/01	13:48:57
5	Alarm 1 Act	2013/11/01	13:49:14
6	Modify Para	2013/10/31	13:56:19
7	Power On	2013/11/06	10:03:33
8	Alarm 1 Act	2013/11/06	10:03:49

HOME UP DOWN Record2

Page Operation Flowchart

3. A Phase measure value diplay

1 A Phase Parameters

Aph Para				2013/09/11 10:42:13
U rms	V	I rms	A	
0.0		0.000		
P	kW	S	kVA	
0.000		0.000		
Q	kvar	PF		
0.000		0.000		

HOME U I P Q S B C Back

Press >> to enter next page

2 A Phase Power

Aph Power		2013/09/11 10:42:13
A	0.000	kVA
	0.000	kW
	0.000	kvar

HOME U I Back

Page Operation Flowchart

3 A Phase Voltage and Current

The screenshot shows the 'Aph V&C' screen with a yellow header bar containing a back arrow, the title 'Aph V&C', and the timestamp '2013/09/11 10:42:13'. A red box with the letter 'A' is in the top left. The main display area shows three red numerical values: '0.0' at the top, '0.000' in the middle, and '0.000' at the bottom. To the right of each value is a grey button with a blue label: 'v', 'A', and 'pFa' respectively. At the bottom, there is a navigation bar with buttons for 'HOME', 'P Q S', and 'BACK'.

Page Operation Flowchart

4. B Phase Measure Value Display :

1 B Phase Parameters

The screenshot shows the 'Bph Para' screen with a yellow header bar containing a back arrow, the title 'Bph Para', and the timestamp '2013/09/11 10:42:13'. The main display is a table with a blue header and grey body rows. The table has four columns: 'U rms', 'V', 'I rms', and 'A'. The data rows show '0.0' under 'U rms', '0.000' under 'I rms', '0.000' under 'P' (kW), and '0.000' under 'S' (kVA). The next row shows '0.000' under 'Q' (kvar) and '0.000' under 'PF'. At the bottom, there is a navigation bar with buttons for 'HOME', 'U I', 'P Q S', 'A', 'C', and 'BACK'.

U rms	V	I rms	A
0.0		0.000	
P	kW	S	kVA
0.000		0.000	
Q	kvar	PF	
0.000		0.000	

2 B Phase Power

The screenshot shows the 'Bph Power' screen with a yellow header bar containing a back arrow, the title 'Bph Power', and the timestamp '2013/09/11 10:42:13'. A black box with the letter 'B' is in the top left. The main display area shows three black numerical values: '0.000' at the top, '0.000' in the middle, and '0.000' at the bottom. To the right of each value is a grey button with a blue label: 'kVA', 'kW', and 'kvar' respectively. At the bottom, there is a navigation bar with buttons for 'HOME', 'U I', and 'BACK'.

Page Operation Flowchart

3 B Phase Voltage and Current

The screenshot shows a mobile application interface for 'Bph V&C' (B Phase Voltage and Current). The title bar is yellow with a back arrow, a right arrow, the text 'Bph V&C', and the timestamp '2013/09/11 10:42:13'. Below the title bar, a large black box with a white letter 'B' is on the left. To its right, three numerical values are displayed: '0.0' (voltage), '0.000' (current), and '0.000' (power factor). Each value has a corresponding button to its right: 'v', 'A', and 'Pfa'. At the bottom, there is a navigation bar with buttons for 'HOME', 'P Q S', and 'BACK'.

Page Operation Flowchart

5. C Phase Measure Value Display

1 C phase Parameters

The screenshot shows a mobile application interface for 'Cph Para' (C phase Parameters). The title bar is yellow with a back arrow, a right arrow, the text 'Cph Para', and the timestamp '2013/09/11 10:42:13'. The display is organized into a table with four rows and two columns. The first row has headers 'U rms' and 'V' in the left column, and 'I rms' and 'A' in the right column. The second row shows values '0.0' and '0.000'. The third row has headers 'P' and 'kW' in the left column, and 'S' and 'kVA' in the right column. The fourth row shows values '0.000' and '0.000'. The fifth row has headers 'Q' and 'kvar' in the left column, and 'PF' in the right column. The sixth row shows values '0.000' and '0.000'. At the bottom, there is a navigation bar with buttons for 'HOME', 'U I', 'P Q S', 'A', 'B', and 'C'.

2 C phase Power

The screenshot shows a mobile application interface for 'Cph Power' (C phase Power). The title bar is yellow with a back arrow, a right arrow, the text 'Cph Power', and the timestamp '2013/09/11 10:42:13'. Below the title bar, a large blue box with a white letter 'C' is on the left. To its right, three numerical values are displayed: '0.000' (kVA), '0.000' (kW), and '0.000' (kvar). Each value has a corresponding button to its right: 'kVA', 'kW', and 'kvar'. At the bottom, there is a navigation bar with buttons for 'HOME', 'U I', and 'BACK'.

Page Operation Flowchart

3 C Phase voltage and current



Page Operation Flowchart

6. Setting Page

In measure status , press SET key more than 3 seconds to enter into set interface:

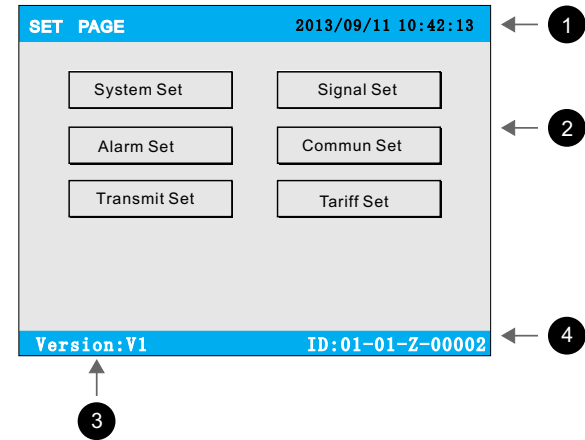

- Set&Select:
- 1 Set Content and meter time
 - 2 Set items is selected by « key or » key
 - 3 Software Version information
 - 4 Meter Ex-facotrySerial Number

Page Operation Flowchart

Page Operation Flowchart

1 System Setting

System Setting		2013/09/11 10:42:13	
Def page :	Home		
Datetime :	2013-12-05 08:20:12		
V_mode :	L-N		
Lightlevel :	10	CLR DMD	
Password :	0	CLR EGY	
Language :	English	CLR EVT	
Reserve :	Disable	Initial	

2 Signal Setting

Signal Setting		2013/09/11 10:42:13	
Input Signal			
PT :	1		
CT :	1		
LINK :	3 - 4		

3 Alarm Setting:

Alarm Setting		2013/09/11 10:42:13	
Alarm 1		Alarm2	
Mode	Ua-H	Mode	Ub-H
Unit	1	Unit	1
Value	250.0	Value	250.0
Hysteresis	10.0	Hysteresis	10.0
ON_DLY	0 S	ON_DLY	0 S
OFF_DLY	0 S	OFF_DLY	0 S

4 Communication Setting

Commun Set		2013/09/11 10:42:13	
Communication			
ADDR :	1		
BAUD :	9600		
DataForm :	little-endian		

5 Transmit Setting

Transmit Set 2013/09/11 10:42:13

Trans1	Trans2
Mode: Ua	Mode: Ub
Unit: 1	Unit: 1
High Limit: 400.0	High Limit: 400.0
Low Limit: 0.0	Low Limit: 0.0

6 Tariff Setting

Tariff Set 2013/09/11 10:42:13

Tariff			
1 Shar	2 peak	3 off pk	4 shoul
5 shar	6 peak	7 off pk	8 shoul

Start Time			
1 0	2 12	3 24	4 36
5 48	6 13	7 7	8 84

Save Read

Chapter 6

Menu Operation
➔ & Illustration

Menu Operation&Illustration

1. The method of Changing the data in data input frame

When cursor is on the data ,press \approx or \approx to pop-up data input frame.

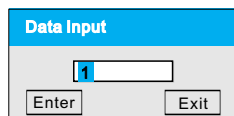

When cursor is on data input frame ,press \approx / \approx to increase or decrease value . Press $\langle\langle$ / $\rangle\rangle$ to shift the cursor to the left or right. Press SET key to confirm. Eg: Input 600 in CT setting frame is as blow:

1. Press SET key for several seconds to enter setting menu.
2. Press $\langle\langle$ / $\rangle\rangle$ to move the cursor to Signal Set menu
3. Press SET key to enter signal setting interface
4. Press $\langle\langle$ / $\rangle\rangle$ to move the cursor to CT menu
5. Press \approx / \approx to pop-up data input frame
6. Press \approx / \approx to change the first digit as 6 , then press $\rangle\rangle$ to move cursor to second digit to make modification. The same operation method for the third digit.

Menu Operation&Illustration

2. Menu formation and function

No.	1st Class	2nd Class	Function Description	Range
1	System Set	Def Page	Default page is home page.	0~13
		Datetime	Set data and time	
		V_mode	Home page voltage display phase voltage or line voltage	
		Lightlevel	Backlight level	1~10
		Password	Set enter menu password	0~999999
		Language	Display language (Chinese or English)	
		Reverse	Disable or Enable	
		CLR DMD	Clear demand value	
		CLR EGY	Clear energy value	
		CLR EVT	Clear event record	
2	Signal Set	Initial	Recovery to default factory setting	
		PT	Voltage ratio= Primary voltage/Secondary voltage	1~400
		CT	Current ratio=primary current/secondary current	1~1000
		LINK	Wire connect mode: 3 phase 3 wire or 3 phase 4 wire	0~1

Menu Operation&Illustration

3	Alarm Set	Alarm 1	Mode	Alarm mode	0~52
			Unit	Alarm unit set as 1 or "K"	0~1 Note ①
			Value	Alarm value (Default value is 250.0)	0~600.0
			Hysteresis	Alarm hysteresis (default value is 10.0)	0~600.0
			ON_DLY	Start Alarm Delay (default value is 0S)	0~999
			OFF_DLY	Stop alarm delay(default value is0S)	0~999
		Alarm 2	Mode	Alarm mode	0~52
			Unit	Alarm unit set as 1 or "K"	0~1 Note ①
			Value	Alarm value (Default value is 250.0)	0~600.0
			Hysteresis	Alarm hysteresis (default value is 10.0)	0~600.0
			ON_DLY	Start Alarm Delay (default value is 0S)	0~999
			OFF_DLY	Stop alarm delay(default value is0S)	0~999
		Alarm 3	Mode	Alarm mode	0~52
			Unit	Alarm unit set as 1 or "K"	0~1 Note ①
			Value	Alarm value (Default value is 250.0)	0~600.0
			Hysteresis	Alarm hysteresis (default value is 10.0)	0~600.0
			ON_DLY	Start Alarm Delay (default value is 0S)	0~999
			OFF_DLY	Stop alarm delay(default value is0S)	0~999

Menu Operation&Illustration

3	Alarm Set	Alarm 4	Mode	Alarm mode	0~52
			Unit	Alarm unit set as 1 or "K"	0~1 Note①
			Value	Alarm value (Default value is 250.0)	0~600.0
			Hysteresis	Alarm hysteresis (default value is 10.0)	0~600.0
			ON_DLY	Start Alarm Delay (default value is 0S)	0~999
			OFF_DLY	Stop alarm delay(default value is0S)	0~999
4	Comm Set	Comm 1	ADDR	Communication address (default 1)	1~254
			BAUD	Baud rate 9600 or 4800	0~1
			DataForm	data bit little-endian or big-endian	0~1
		Comm 2	ADDR	Communication address (default 1)	1~254
			BAUD	Baud rate 9600 or 4800	0~1
			DataForm	data bit little-endian or big-endian	0~1
5	Trans Set	Trans1	Mode	Transmit mode	1~26
			Unit	Transmit unit can be set as 1 or K	0~1 Note ①
			High Limit	Transmit high limit (default 0.0)	0~600.0
		Trans2	Low Limit	Transmit low limit (default 400.0)	0~600.0
			Mode	Transmit mode	1~26
			Unit	Transmit unit can be set as 1 or K	0~1 Note ①
High Limit	Transmit high limit (default 0.0)	0~600.0			
Low Limit	Transmit low limit (default 400.0)	0~600.0			

5	Trans Set	Trans 3	Mode	Transmit mode	1~26
			Unit	Transmit unit is set as 1 or K	0~1 Note①
			High Limit	Transmit high limit (default 0.0)	0~600. 0
			Low Limit	Transmit low limit(default 400.0)	0~600. 0
6	Tariff Set	Tariff	1	Sharp Rate (Default)	0~3
			2	Peak Rate(default)	0~3
			3	Off-Peak Rate(default)	0~3
			4	Shoulder Rate(default)	0~3
			5	Sharp Rate (Default)	0~3
			6	Peak Rate(default)	0~3
			7	Off-Peak Rate(default)	0~3
			8	Shoulder Rate(default)	0~95
	Start Time	1	Default start time is 0 clock	0~95	
		2	Default start time is 3 clock	0~95	
		3	Default start time is 6 clock	0~95	
		4	Default start time is 9 clock	0~95	
		5	Default start time is 12 clock	0~95	
		6	Default start time is 15 clock	0~95	
		7	Default start time is 18 clock	0~95	
		8	Default start time is 21 clock	0~95	

- 1: International standard unit.
K: 1000 times international standard unit , alarm value and alarm hysteresis unit are the same.

Chapter 7

Communication
 Protocol

Communication Protocol

EW9T meter adopt Modbus RTU protocol Rs485 half duplex communication , read function code is 0x03, write function code is 0x10, adopt 16 digit CRC check bit . Meter does not feedback the check error.

Data format is as blow:

Start bit	Data bit	Stop bit	Check bit
1	8	1	No

Communication abnormal solution:

When abnormal answer , the highest bit of function code will be set to 1. Eg: If the request function code from host is 0x04 , function code from slaver is 0x84.

Error type code:

- 0x01---Function code error: Meter does not support the function code it receives.
- 0x02---Data position error: The data position sent by host is out of range of meter.
- 0x03---Data value error: The data value sent from host is out of range of meter.

1 Read Multi-register

Eg: Host reads UA (A phase voltage)

Ua address code is 0x4000,becasue Ua is fixed point number (4 byte), seizes 2 data register. 220.000V data bit is 0x00035B60

Host Request							
1	2	3	4	5	6	7	8
Meter address	Function code	Start address high bit	Start address low bit	Data length high bit	Data length low bit	CRC code low bit	CRC code high bit
0X01	0X03	0X40	0X00	0X00	0X02	0XD1	0XCB

Communication Protocol

Slaver Normal Answer (Big-endian)								
1	2	3	4	5	6	7	8	9
Meter address	Function code	Databyte number	Data1 high bit	Data1 low bit	Data2 high bit	Data2 low bit	CRC code low bit	CRC code high bit
0X01	0X03	0X04	0X00	0X03	0X5B	0X60	0X31	0X2B

Slaver Normal Answer (Little-endian)								
1	2	3	4	5	6	7	8	9
Meter address	Function code	Databyte number	Data1 high bit	Data1 low bit	Data2 high bit	Data2 low bit	CRC code low bit	CRC code high bit
0X01	0X03	0X04	0X5B	0X60	0X00	0X03	0XA9	0X0B

Function code abnormal answer:(eg:host request function code is 0x04)

Slaver abnormal answer(Read multi-register)				
1	2	3	8	9
Meter address	Function code	Error code	CRC code low bit	CRC code high bit
0X01	0X84	0X01	0X82	0XC0

2 Wirte Multi-register

Eg: Host Write Fixed piont number of Alarm 1 mode AH:
If PT address code is 0x4800, because AH is fixed point number,seize 1 data register. 11 Decimalist code is 0X000B.

Communication Protocol

Communication Protocol

Host Request (Write multi-register)										
1	2	3	4	5	6	7	8	9	10	11
Meter address	Function code	start address high bit	Start address low bit	databyte length high bit	Databyte length low bit	Data byte length	Data 1 high bit	Data 1 low bit	Data 2 high bit	Data 2 low bit
0X01	0X10	0X48	0X00	0X00	0X01	0X02	0X00	0X0B	0XFF	0X37

Slaver Normal Answer(Write multi-register)							
1	2	3	4	5	6	7	8
Meter Address	Function code	Start address high 8 bit	Start address low 8 bit	Databyte length high bit	Databyte length low bit	CRC code low bit	CRC code high bit
0X01	0X10	0X48	0X00	0X00	0X01	0X16	0X69

Data position error answer: (eg: Master request write address index is 0x0050)

Slaver Abnormal Answer(write multi-register)				
1	2	3	4	5
Meter address	Function code	Error code	CRC code low bit	CRC code high bit
0X01	0X90	0X02	0XCD	0XC1

Parameters address reflection table Note: Address code index

No.	Address Reflection	Variable Name	Byte	Value Range	Read/Write	Remark
01	0X4000	Phase voltage A	2	long	R	0.001V
02	0X4002	Phase voltage B	2	long	R	
03	0X4004	Phase voltage C	2	long	R	
04	0X4006	line voltage AB	2	long	R	
05	0X4008	line voltage BC	2	long	R	
06	0X400a	Line voltage CA	2	long	R	
07	0X400c	Phase current A	2	long	R	0.001A
08	0X400e	Phase current B	2	long	R	
09	0X4010	Phase current C	2	long	R	
10	0X4012	A phase active power	2	long	R	0.001KW
11	0X4014	B phase active power	2	long	R	
12	0X4016	C phase active power	2	long	R	
13	0X4018	Total active power	2	long	R	
14	0X401a	Reactive power A	2	long	R	0.001Kvar
15	0X401c	Reactive power B	2	long	R	
16	0X401e	Reactive Power C	2	long	R	
17	0X4020	Total reactive power	2	long	R	

Communication Procotol

18	0X4022	Apparent power A	2	long	R	0.001KVA
19	0X4024	Apparent power B	2	long	R	
20	0X4026	Apparent power C	2	long	R	
21	0X4028	Total apparent power	2	long	R	
22	0X402a	Power factor A	2	long	R	0.001
23	0X402c	Power factor B	2	long	R	
24	0X402e	Power factor C	2	long	R	
25	0X4030	Total power factor	2	long	R	
26	0X4032	Frequency	2	long	R	0.001HZ
27	0X4034	Total kWh	2	long	R	0.001Kmh
28	0X4036	Total kvarh	2	long	R	
29	0X4038	Forward kWh	2	long	R	
30	0X403a	Inverse kWh	2	long	R	
31	0X403c	Forward kvarh	2	long	R	
32	0X403e	Inverse kvarh	2	long	R	
33	0X4042	Current demand	2	long	R	0.001
34	0X4044	Current Max demand	2	long	R	
35	0X4046	Kw demand	2	long	R	
36	0X4048	Max Kw demand	2	long	R	
37	0X404a	Kvar demand	2	long	R	
38	0X404c	Max kvar demand	2	long	R	

Communication Procotol

39	0X404e	kVA demand	2	long	R	0.001
40	0X4050	Max KVA demand	2	long	R	
41	0X4052	Ua total harmonic distortion (THDUa %)	2	long	R	0.1
42	0X4054	Ub total harmonic distortion (THDUb %)	2	long	R	
43	0X4056	Uc total harmonic distortion (THDUc %)	2	long	R	
44	0X4058	Ia total harmonic distortion (THDIa %)	2	long	R	
45	0X405a	Ib total harmonic distortion (THDIb %)	2	long	R	
46	0X405c	Ic total harmonic distortion (THDIc %)	2	long	R	
Reserve						
47	0X4100	Total Tariff energy	2	long	R	0.001Kwh
48	0X4102	Total Sharp tariff energy	2	long	R	
49	0X4104	Total Peak tariff energy	2	long	R	
50	0X4106	Total off-peak tariff energy	2	long	R	
51	0X4108	Total shoulder tariff energy	2	long	R	
52	0X410a	Total kWh this month	2	long	R	
53	0X410c	Sharp kWh this month	2	long	R	
54	0X410e	Peak kWh this month	2	long	R	
55	0X4110	off-peak kWh thismonth	2	long	R	
56	0X4112	Shoulder kWh this month	2	long	R	
57	0X4114	Total kWh last month	2	long	R	
58	0X4116	Sharp kWh last month	2	long	R	

Communication Protocol

59	0X4118	Peak kWh last month	2	long	R	0.001kWh
60	0X411a	Off-peak kWh last month	2	long	R	
61	0X411c	Shoulder kWh last month	2	long	R	
62	0X411e	Total kWh last II month	2	long	R	
63	0X4120	Sharp kWh last II month	2	long	R	
64	0X4122	Peak kWh last II month	2	long	R	
65	0X4124	Off-peak kWh last II month	2	long	R	
66	0X4126	Shoulder kWh last II month	2	long	R	
Reserve						
67	0X4800	Voltage transformer PT1	2	long	R/W	0.001
68	0X4802	Voltage transformer PT2	2	long	R/W	
69	0X4804	Current transformer CT1	2	long	R/W	
70	0X4806	Current transformer CT2	2	long	R/W	
71	0X4808	The alarm1 value	2	long	R/W	
72	0X480a	Alarm 1 hysteresis	2	long	R/W	0.001
73	0X480c	Alarm 2 value	2	long	R/W	
74	0X480e	Alarm 2 hysteresis	2	long	R/W	
75	0X4810	Alarm 3 value	2	long	R/W	
76	0X4812	Alarm 3 hysteresis	2	long	R/W	
77	0X4814	Alarm 4 value	2	long	R/W	
78	0X4816	Alarm 4 hysteresis	2	long	R/W	

Communication Protocol

79	0X4818	Transmit 1 high limit	2	long	R/W	0.001
80	0X481a	Transmit 1 low limit	2	long	R/W	
81	0X481c	Transmit 2 high limit	2	long	R/W	0.001
82	0X481e	Transmit 2 low limit	2	long	R/W	
83	0X4820	Transmit 3 high limit	2	long	R/W	
84	0X4822	Transmit 3 low limit	2	long	R/W	
Reserve						
85	0X4900	Alarm 1 mode	1	int	R/W	No decimal point
86	0X4901	Alarm 1 unit	1	int	R/W	
87	0X4902	Alarm 1 on delay	1	int	R/W	
88	0X4903	Alarm 1 off delay	1	int	R/W	
89	0X4904	Alarm 2 mode	1	int	R/W	
90	0X4905	Alarm 2 unit	1	int	R/W	
91	0X4906	Alarm 2 on delay	1	int	R/W	
92	0X4907	Alarm 2 off delay	1	int	R/W	
93	0X4908	Alarm 3 mode	1	int	R/W	
94	0X4909	Alarm 3 unit	1	int	R/W	
95	0X490a	Alarm 3 on delay	1	int	R/W	
96	0X490b	Alarm 3 off delay	1	int	R/W	
97	0X490c	Alarm 4 mode	1	int	R/W	
98	0X490d	Alarm 4 unit	1	int	R/W	

Communication Protocol

99	0X490e	Alarm 4 on delay	1	int	R/W	No decimal point
100	0X490f	Alarm 4 off delay	1	int	R/W	
Reserve						
101	0X4980	Transmit 1 mode	1	int	R/W	No decimal point
102	0X4981	Transmit 1 unit	1	int	R/W	
103	0X4982	Transmit 2 mode	1	int	R/W	
104	0X4983	Transmit 2 unit	1	int	R/W	
105	0X4984	Transmit 3 mode	1	int	R/W	
106	0X4985	Transmit 3 unit	1	int	R/W	
Reserve						
107	0X4a00	Link mode	1	int	R/W	No decimal point
108	0X4a01	Communication address	1	int	R/W	
109	0X4a02	Baud rate	1	int	R/W	
110	0X4a03	Dataformat	1	int	R/W	
111	0X4a04	Switch output	1	int	R/W	
112	0X4a05	Switch input	1	int	R/W	
113	0X4a06	DI (digit input)	1	int	R/W	
Reserve						
114	0X4a80	Tariff Rate 1	1	int	R/W	No decimal point
115	0X4a81	Tariff Rate 2	1	int	R/W	
116	0X4a82	Tariff Rate 3	1	int	R/W	

Communication Protocol

117	0X4a83	Tariff rate 4	1	int	R/W	No decimal point
118	0X4a84	Tariff rate 5	1	int	R/W	
119	0X4a85	Tariff rate 6	1	int	R/W	No decimal point
120	0X4a86	Tariff rate7	1	int	R/W	
121	0X4a87	Tariff rate 8	1	int	R/W	
122	0X4a8c	Tariff rate 1 time priod	1	int	R/W	
123	0X4a8d	Tariff rate 2 time period	1	int	R/W	
124	0X4a8e	Tariff rate 3 time period	1	int	R/W	No decimal point
125	0X4a8f	Tariff rate 4 time period	1	int	R/W	
126	0X4a90	Tariff rate 5 time period	1	int	R/W	
127	0X4a91	Tariff rate 6 time period	1	int	R/W	
128	0X4a92	Tariff rate 7 time period	1	int	R/W	
129	0X4a93	Tariff rate 8 time period	1	int	R/W	
	0X5000	Reserve				
		Motor protect communication data				
		A phase short circuit current	1	int	R/W	
		Reserve				

Communication Protocol

```
16 bitCRC check code
unsigned int Get_CRC (uchar*pBuf, uchar num)
{
    unsigned i, j;
    unsigned int wCrc=0xFFFF
    for (i=0; i<num; i++)
    {
        wCrc^= (unsigned int) (pBuf[i] );
        for (j=0 ; j<8 ; j++)
        {
            if (wCrc&1) {wCrc>>=1; wCrc=0xA001; }
            else wCrc >>=1;
        }
    }
    return wCrc;
}
```

Intelligent Power Meter

Operation Manual

When Installing and using the meter , please refer to the manual.