

# Module Type Temperature Controller

For GTF2-B Version



## Features:

- Optional input signal types.
- With many functions, measured display, control output, alarm output, analog output, RS485 communication, etc.
- Optional many types of PID arithmetic, and with auto-tuning function.
- Using for industrial machinery, machine tools, measuring instruments.
- Economical and easy operation.

National High-tech Enterprise/ National Standard Drafting Unit



Hotline: 400-8866-986

Version code: KKGTF2-B01E-A/0-20210415

The instruction explain instrument settings, connections, name and etc, please read carefully before you use the temperature controller. Please keep it properly for necessary reference.

## I. Safe Caution

### Warning

- When the failure or abnormal of products lead to a system of major accidents, please set the proper protection circuit in the external.
- Please don't plug in before completing all the wire. Otherwise it may lead to electric shock, fire, fault.
- Not allow to use outside the scope of product specification, otherwise it may lead to fire, fault.
- Not allow to use in the place where is inflammable and explosive gas.
- Do not touch power terminal and other high voltage part when the power on, otherwise you may get an electric-shock.
- Do not remove, repair and modify this product, otherwise it may lead to electric shock, fire, fault.

### Caution

- The product should not be used in a nuclear facility and human life associated medical equipment.
- The product may occur radio interference when it used at home. You should take adequate countermeasures.
- The product get an electric shock protection through reinforced insulation. when the product is embedded in the devices and wiring, please subject to the specification of embedded devices.
- In order to prevent surge occurs, when using this product in the place of over 30m indoor wiring and wiring in outdoor, you need to set the proper surge suppression circuitry.
- The product is produced based on mounting on the disk. In order to avoid to touch the wire connectors, please take the necessary measures on the product.
- Be sure to observe the precautions in this manual, otherwise there is a risk of a major injury or accident.
- When wiring, please observe the local regulation.
- To prevent to damage the machine and prevent to machine failure, the product is connected with power lines or large capacity input and output lines and other methods please install proper capacity fuse or other methods of protection circuit.
- Please don't put metal and wire clastic mixed with this product, otherwise it may lead to electric shock, fire, fault.
- Please tighten screw torque according to the rules. If not, it may lead to electric shock and fire.
- In order not to interfere with this products to dissipate heat, please don't plug casing around the cooling vent hole and equipment.
- Please don't connect any unused terminal.
- Please do the cleaning after power off, and use the dry cleaning cloth to wipe away the dirt. Please don't use desiccant, otherwise, it may casue the deformation or discoloration of the product.
- Please don't knock or rub the panel with rigid thing.
- The readers of this manual should have basic knowledge of electrical, control, computer and communications.
- The illustration, example of data and screen in this manual is convenient to understand, instead of guaranteeing the result of the operation.
- In order to use this product with safety for long-term, regular maintenance is necessary. The life of some parts of the equipments are by some restrictions, but the performance of some will change for using many years.
- Without prior notice, the contents of this manual will be change. We hope these is no any loopholes, if you have questions or objections, please contact us.

## Caution of Instal & Connection

- Installation
  - This product is used in the following environmental standards. (IEC61010-1) [Overvoltage category II, class of pollution 2]
  - This product is used in the following scope: environment, temperature, humidity and environmental conditions. Temperature: 0~50°C; humidity: 45~85%RH; Environment condition: Indoor warranty. The altitude is less than 2000m.
  - Please avoid using in the following places:
    - The place will be dew for changing temperature; with corrosive gases and flammable gas; with vibration and impact; with water, oil, chemicals, smoke and steam facilities with Dust, salt, metal powder; and with clutter interference, static electric and magnetic fields, noise; where has air conditioning or heating of air blowing directly to the site; where will be illuminated directly by sunlight; where accumulation of heat will happen caused by radiation.
  - On the occasion of the installation, please consider the following before installation.
    - In order to protect heat saturated, please ensure adequate ventilation space. Please consider connections and environment, and ensure that the products below for more than 50mm space. Please avoid to installed over the machine of the calorific value (Such as heaters, transformer, semiconductor operations, the bulk resistance). When the surrounding is more than 50, please using the force fan or cooling fans. But don't let cold air blowing directly to the product. In order to improve the anti-interference performance and security, please try to stay away from high pressure machines, power machines to install.
    - Don't install on the same plate with high pressure machine and the product. The distance should be more than 200mm between the product and power line.

2. Cable caution:

- Please use specified compensation wire in the place of TC input; Please use insulated TC if the measured device is heated metal.
- Please use the cable of lesser resistance in the place of RTD input, and the cable (3 wire) must be no resistance difference, but the total length is within 5m.
- In order to avoid the effect of noise, please put the input signal away from meter cable, power cable, load cable to wiring.
- In order to reduce the power cables and the load power cables on the effect of this product, please use noise filter in the place where easy to effect. You must install it on the grounding of the disk if you use the noise filter, and make the wiring to be shortest between noise filter output side and power connectors. Don't install fuse and switch on the wiring of noise filter output side, otherwise it will reduce the effect of noise filter.
- It takes 5s from input power to output. If there is a place with interlocking actions circuit signal, please use timer relay.
- Please use twisted pair with a shield for analog output line, can also connect the common-mode coil to the front-end of the signal receiving device to suppress line interference if necessary, to ensure the reliability of signal.
- Please use twisted pair with a shield for remote RS485 communication cable, and deal with the shield on the host side earth, to ensure the reliability of signal.
- This product don't have the fuse; please set according to rated voltage 250V, rated current 1A if you need; fuse type: relay fuse.
- Please use suitable slotted screwdriver and wire.
- Terminal distance: 5.0mm. Screwdriver size: 0.6X3.5, length of slotted screwdriver >130mm. Recommended tightening torque: 0.5N.m. Proper cables: 0.25 ~ 1.65mm single cable/multiple core cable
- Please don't put the Crimp terminal or bare wire part contact with adjacent connector.

- Ordering Information
  - B: Version
  - Blank: TC/RTD/mV/Rt input X: mA/V input
  - 10: Single input without RS485 18: with RS485
  - 1: 1 alarm output 2: 2 alarm output 0: No alarm
  - M: SSR/Relay R: Relay output S: SSR output C: DC 4-20mA (can be changed to analog output through ACT menu)
  - K: SCR output (can be ordered)
  - I: 4 ~ 20mA analog output (can be set to current output through ACT menu) Blank: No
  - Blank: AC/DC 100 ~ 240V F: AC/DC 24V
  - 2: 2.2.5WX110HX115L
  - GTF series module type temperature controller

Please note input signal type when choose the model. 1st type TC/RTD/mV/Rt; 2nd type: mA/V.

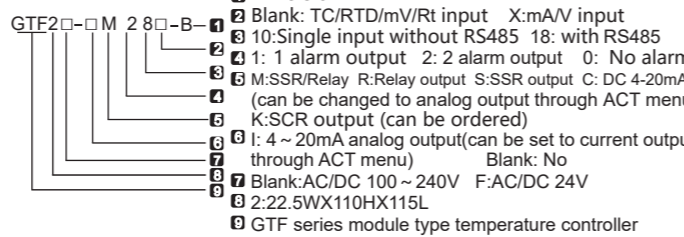

## III. Ordering Information

Model	Control output function	Alarm	Analog output 4~20mA	RS485
GTF2-IM28	SSR, relay output / 4~20mA	2	Yes	No
GTF2-M28	SSR, relay output	2	No	No
GTF2-IM2	SSR, relay output / 4~20mA	2	Yes	Yes
GTF2-M2	SSR, relay output	2	No	Yes

## IV. Specifications

### 1. Electrical parameters:

Sample rate	2 times per second
Relay capacity	AC 250V /1A lifespan of rated load > 100,000 times (Resistive load)
Power supply	AC/DC 100 ~ 240V (85-265V) or AC/DC 24V
Power consumption	< 6VA
Environment	Temperature of indoor: 0 ~ 50°C no condensation, Humidity: < 85%RH, altitude < 2000m
Storage environment	-10 ~ 60°C, no condensation
SSR output	DC 24V pulse level, load < 30mA
Current output	DC 4 ~ 20mA load < 500Ω, temperature drift 250PPM
Communication port	RS485 port, Modbus-RTU protocol, max input 30 units
Insulation impedance	Input, output, power cabinet > 20MΩ
ESD	IEC/EN61000-4-2 Contact ±4KV / Air ±8KV perf. CriGTEria B
Pulse triap anti-interference	IEC/EN61000-4-4 ±2KV perf. CriGTEria B
Surge immunity	IEC/EN61000-4-5 ±2KV perf. CriGTEria B
Voltage drop & short interruption immunity	IEC/EN61000-4-29 0% ~ 70% perf. CriGTEria B
Dielectric strength	Signal input and output & power 1500VAC 1min, below 60V Low voltage circuit between DC500V, 1min
Total weight	About 400g
Shell material	PA66-FR (Flame Class UL94V-0)
Panel material	PVC film and PEM silicone key
Power-off data protection	10 years, times of writing: 1 million times
Safety Standard	IEC61010-1 Overvoltage category II, pollution level 2, level II (Enhanced insulation)

## 2. Measured signal specifications:

Input type	Symbol	Measuring range	Resolution	Accuracy	Input impedance/auxiliary current	Communication parameter code
K	℄	-50 ~ 1200	1°C	0.5%F.S±3digits	> 500kΩ	0
J	℄	0 ~ 1200	1°C	0.5%F.S±3digits	> 500kΩ	1
E	℄	0 ~ 850	1°C	0.5%F.S±3digits	> 500kΩ	2
T	℄	-50 ~ 400	1°C	0.5%F.S±3°C	> 500kΩ	3
B	℄	250 ~ 1800	2°C	1%F.S±2°C	> 500kΩ	4
R	℄	-10 ~ 1700	1°C	1%F.S±2°C	> 500kΩ	5
S	℄	-10 ~ 1600	1°C	1%F.S±2°C	> 500kΩ	6
N	℄	-50 ~ 1200	1°C	0.5%F.S±1°C	> 500kΩ	7
PT100	℄	-200 ~ 600	0.2°C	0.5%F.S±0.3°C	0.2mA	8
JPT100	℄	-200 ~ 500	0.2°C	0.5%F.S±0.3°C	0.2mA	9
CU50	℄	-50 ~ 150	0.2°C	0.5%F.S±3°C	0.2mA	10
CU100	℄	-50 ~ 150	0.2°C	0.5%F.S±1°C	0.2mA	11
0 ~ 50mV	℄	-1999 ~ 9999	12bit	0.5%F.S±3digits	> 500kΩ	12
0 ~ 400V	℄	-1999 ~ 9999	12bit	0.5%F.S±3digits	0.2mA	13
*4 ~ 20mA	℄	-1999 ~ 9999	12bit	0.5%F.S±3digits	100Ω	14
*0 ~ 10V	℄	-1999 ~ 9999	12bit	0.5%F.S±3digits	> 1MΩ	15

\* Please note when you choose the model

## 3. Isolation diagram:

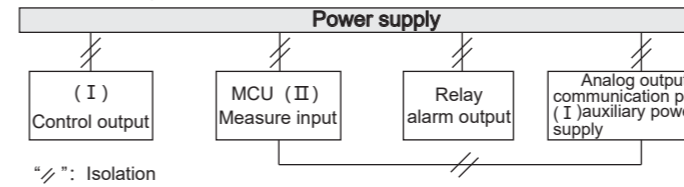

## V. Dimension and installation size

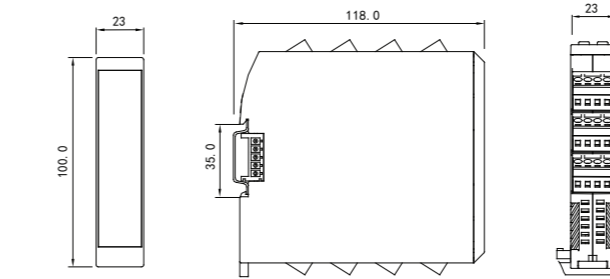

## VI. Connection

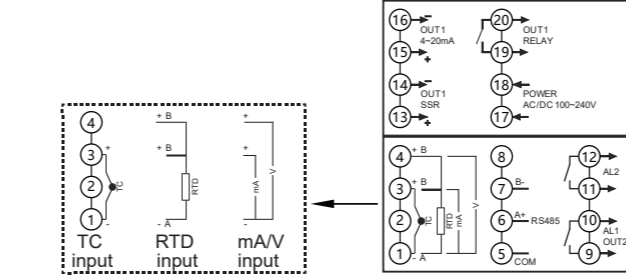

Note: If there is any change, please subject to the drawing on the meter

## VII. Name of universal panel

No	Symbol	Name	Function
1	SET	SET function key	Menu key/confirm key, used to enter or exit parameter modification mode or confirm modified value
2	◀	Shift /AT key	Activation key/shift key/AT auto-tune key; under the measure control mode, long press it to enter or exit auto-tune.
3	⬆	Add key /R/S	Add key/ menu shifting key; under the measure control mode, long press it to switch the RUN/ STOP mode
4	⬇	Reduce key	Reduce key/ menu shifting key
	PV	PV	Measured value, display measured value or menu symbol.
	SV	SV	Set value, display set value or menu parameter.
	OUT1	OUT1	OUT1 LED, light up when OUT ON, light off when OUT OFF.
	OUT2	OUT2	OUT2 LED, light up when OUT ON, light off when OUT OFF.
	AL1	AL1	AL1 indicator, light up when alarm ON, light off when alarm OFF.
	AL2	AL2	AL2 indicator, light up when alarm ON, light off when alarm OFF.
	AT	AT	AT indicator, light up when auto-tune, light off when no auto-tune or the auto-tune is finished.
	°F °C	°C °F	Unit indicator

## 1. Operation process & method

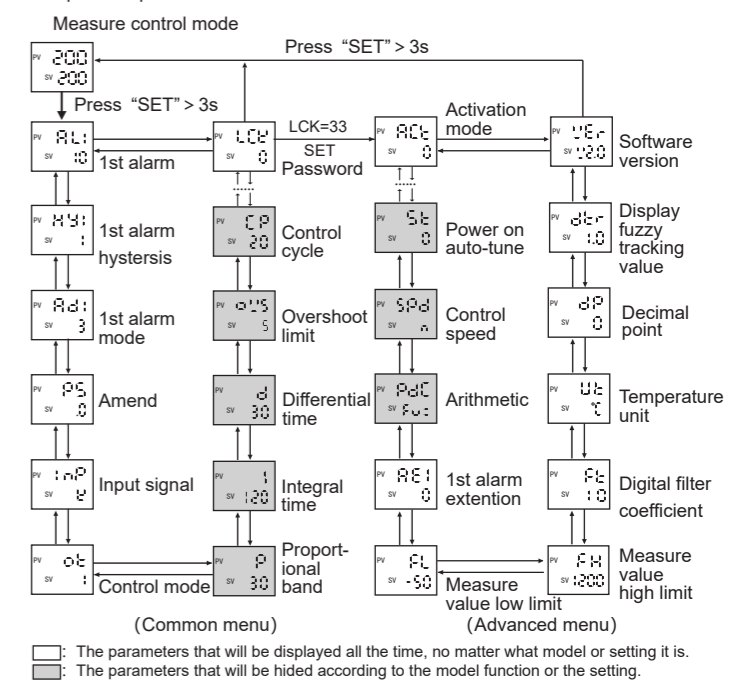

(Common menu) (Advanced menu)

- Operation:
- After power on and under normal measure control mode, long press "SET" key more than 3s to enter the menu parameters checking mode.
  - In the menu checking mode, press "SET" key to check the menu parameters circularly.
  - In the menu checking mode, short press "◀" can flash the current menu parameters to enter the parameter modify mode, and every short press can move one position to the left, in this cycle.
  - In the parameter modifying mode, press "⬆" or "⬇" key once to add or reduce one of flashing data.
  - In the parameter modifying mode, after the modification, press "SET" to save the modified parameter, and exit to menu checking mode.
  - In the normal measure control mode, short press "◀" to enter SV value modifying status. The way of modifying SV value is same as that of modifying menu parameters.
  - In the normal measure control mode, long press "◀" more than 3s to enter auto-tuning state. During auto-tuning, PV value needs to be lower than SV value.
  - In the normal measure control mode, long press "⬆" key more than 3s to enter or exit monitoring mode, RUN/STOP mode.

No	Symbol	Name	Illustration	Setting range	Factory setting
1	℄	AL1	1st alarm value, note: the minus is dealt as absolute value when it is as a deviation value.	FL ~ FH	10
2	℄	HY1	1st alarm hysteresis	0 ~ 1000	1
3	℄	AD1 (1)	1st alarm mode, note: when AL1 is used as OUT2 (cooling output), should set the value AD1=0 (close alarm function). When AD1>6, 2nd alarm function is invalid. Pls refer to "(1) Alarm parameters & output logic diagram"	0 ~ 12	3
4	℄	AL2	2nd alarm value, note: the minus is dealt as absolute value when it is as a deviation value.	FL ~ FH	5
5	℄	HY2	2nd alarm hysteresis	0 ~ 1000	1
6	℄	AD2 (1)	2nd alarm mode, pls refer to "(1) Alarm parameters & output logic diagram"	0 ~ 6	4
7	℄	PS	Amend value, display value= actual measured value + amend value	FL ~ FH	0
8	℄	INP	Optional input signal, refer to input signal parameters table. Note: after selecting the signal, pls set below relevant parameters: SV, AL1, HY1, AL2, HY2, P, OVS, DB.	Refer to "2" measured signal specification	K
9	℄	Q	Control mode, 0: ON/OFF heating control, relevant parameter: DB. 1: PID heating control, relevant parameters: P, I, D, OVS, CP, ST, SPD, PDC. 2: ON/OFF cooling control, relevant parameter DB; need to set PT when it is used for compressor control. 3: PID heating & cooling control (cooling control OUT2 will output through AL1 relay), relevant parameters: P, I, D, OVS, CP, CP1, PC, DB, ST, SPD, PDC. 4: Over temperature cooling output, relevant parameter: DB. 5. PID cooling, relevant parameter: P, I, D, OVS, CP, ST, SPD, PDC.	0 ~ 5	1
10	℄	A-M	Auto-manual control switch, AUTO(0): auto control only; MAN(1): manual control only; AM(2): auto-manual shortcut switch	AUTO~AM	AUTO
11	℄	P	Proportional band, the smaller the value is, the faster the system responds, otherwise, it is slower. When P=0, no PID control, unit same as PV	0 ~ 9999	30
12	℄	I	Integral time, the smaller the value is, the stronger the integral action is, otherwise, it is weaker. When I=0, no integral action, unit: s.	0 ~ 9999	120
13	℄	D	Differential time, the greater the value is, the stronger the differential action is, otherwise, it is weaker. When D=0, no differential action. Set D=0 when controlling fast systems, such as pressure, speed, etc, unit: s	0 ~ 9999	30

14	α'S	OVS	Overshoot limit, during PID control process, when PV(measured value) > SV(set value) + OVS(overshoot limit), force to close output. The smaller this value is, the smaller the PID adjustment range is, the worse the control stability is. Please set the appropriate value according to the actual situation.	0 ~ 9999	5
15	CP	CP	OUT1 control cycle, 1: SSR control output, 4-200: relay control output. Unit:s	1 ~ 200	20
16	CP1	CP1	OUT2 relay output cycle. Unit: S	4 ~ 200	20
17	PC	PC	OUT2 cooling proportionality coefficient, the higher of value, the stronger of cooling	1 ~ 100	10
18	DB	DB	ON/OFF control hysteresis(positive and negative numbers work the same); when OT=3, it is the dead zone for cooling control(positive and negative numbers work differently);after change the INP setting, please change this parameter according to the decimal point position.	-1000~1000	5
19	LCK	LCK	Lock function; 0001: SV value can not be changed; 0010: menu setting value can be read only; 0033: advanced menu can be accessed; 0123: menu restore factory settings	0~9999	0

(1) Alarm parameters and output logic diagram:  
Symbol description: "☆" means HY, "▲" means alarm value, "△" means SV value

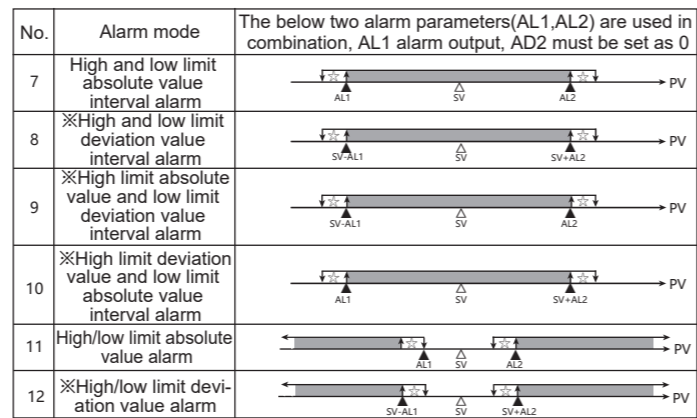
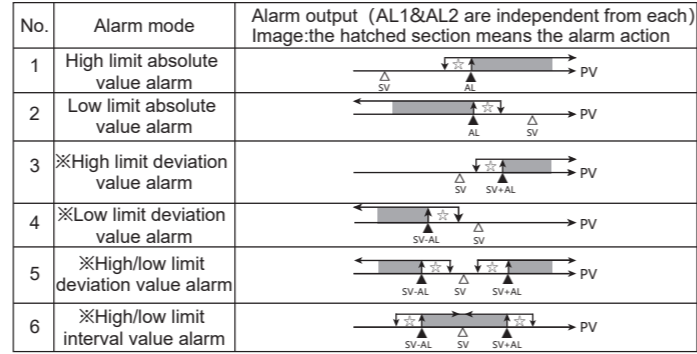

※When the alarm value with deviation alarm is set as a negative number, it will be dealt as an absolute value.

(2) Alarm extension function table

AE1/AE2 value	Alarm handling method when it displays HHHH/LLLL	Remark
Power on, alarm	0 The alarm remains the state 1 second before it displays HHHH/LLLL	As long as the alarm condition is met, alarm will output.
does not inhibit	1 Forced alarm output	
Power on, alarm inhibit	2 Forced alarm close	Before the PV value reaches the SV for the first time, the alarm will not output
	3 The alarm remains the state 1 second before it displays HHHH/LLLL	
	4 Forced alarm output	
	5 Forced alarm close	

IX. Key function operation

- Monitoring mode operation (RUN/STOP)
  - Under the measure mode, long press "▲" to enter the monitoring mode, and it will display "STOP" on the SV window. Long press "▲" to exit.
  - It can modify SV value and switch operation mode even displaying STP.
  - Under the monitoring mode, main control output will stop or set min output except alarm output and analog output.
- PID parameter identification and auto-tune operation:
  - The factory default PID parameters usually does not apply to usage occasion; please use auto-tuning function to get a suitable PID parameter.
  - The meter will enter control output since power on, so please set the monitoring mode to avoid any influence on the auto-tune effect, or switch off the power of control output load. No matter how it operates, should guarantee the set value greater than the current measured value, and the bigger the drop is, the better it will be.
  - In order to avoid the influence caused by alarm interlocking output, please set the proper alarm value in advance, or exclude the alarm influence.
  - Set PID type and SV value;the factory default setting is fuzzy PID.
  - Set as PID control, if there is OLL & OLH output limiting, please set the output to a proper range; factory default setting is OLL=0%, OLH=100%.
  - Under the condition that PV value is at normal room temperature, please exit monitoring mode or power on the load, and long press "▲" to enter auto-tune mode, then, AT indicator is on.
  - Auto-tune will take some time, in order not to affect auto-tune result, please don't modify the parameters or power-off.
  - When AT light goes out, it automatically exits auto-tune mode, PID parameters will be updated automatically, at that time, it will auto control exactly.
  - It will stop the auto-tune if long press "▲" key, measure beyond the scope, display abnormally, switch to "STOP" mode, or power-off in the process of auto-tune.
  - Note: In the occasions with output limiting operation, sometimes, even if the auto-tune is carried out, the best PID parameters still cannot be obtained.
- PID & Cooling control operation
  - PID control acts on mail control output OUT1, cooling control acts on OUT2.
  - AL1 alarm and OUT2 are multiplex function, when using the cooling control, please set AD1 as 0; the 1st alarm function will not work after setting.
  - Please set the control mode OT as 3.
  - Please set the cooling start hysteresis DB to a value greater than 5, to ensure the cooling would not affect the PID control.
  - Please change the cooling control cycle CP1 to a proper value, and change the cooling proportionality coefficient to a proper value.
  - When PV value > SV+DB value, the cooling control start to effect; the bigger value of PV, the longer output time of OUT2
- Auto-manual switch function
  - Enter common manual, set parameter A-M as "AM".
  - After return back to measure control interface, press SET key to switch auto-manual operation.

- When it is switched to manual control, lower line LED will display output percentage: M0~M100 (corresponding to 0%~100%), press Add Key or Reduce Key to modify the output percentage.
- Before the manual control is switched to auto control, press Left Key to modify the SV value, so as to switch the control mode smoothly.
- After the meter is rebooted, the default setting is manual control and output 0.
- Fix manual control function
  - Set A-M parameter as "MAN".
  - After return back to measure control interface, user can modify output percentage by manual.
  - After the meter is powered on again, the manual output percentage can be restored.
- Linear signal self calibration function operation
  - Set up the INP type, and ensure it is one of these input 0 ~ 50mV, RT(0 ~ 400 Ω), 4 ~ 20mA and 0 ~ 10V.
  - Add the input signal to the correct input channel.
  - Enter menu low-limit calibration CAL menu, press "◀" to flash "YES"; and set the input signal to minimum value and input it to the meter.
  - When "YES" is flashing, and the minimum value of the signal has been input to the meter, please press "SET" to ensure and save the calibrating value.
  - After calibrating low-limit, enter the high-limit calibration CAH menu, and flash "YES".
  - Set the input signal to maximum value and input it into the meter, and press "SET" to ensure and save the calibrating value when the "YES" is flashing.
  - After calibrating, enter CAE menu, change "N" to "Y" to enable the calibrating value; otherwise, it still use the factory default value.
  - The linear signal value of high-limit input should not exceed the input standard value range ±10%.
  - If not satisfied with the calibrating result, could calibrate again.

X. Methods of simple fault

Display	Checking method
LLLL/HHHH	Check the wire connection, FH and FL value, working environment temperature and whether input signal is selected correctly.

XI. Communication protocol

Meter use Modbus RTU to do RS485 half-duplex communication. Reading function code 0x03, writing function code 0x10/0x06. The meter use 16digits CRC to check and will not feedback any information of checked error.  
Data frame format:

Start bit	Data bit	Stop bit	Check bit
1	8	1	Setting in Menu PRTY

Handling of abnormal communication:  
If there is abnormal response, put 1 on the highest bit of function code.  
For example: Host request function code is 0x03, and the response function code from guest should be 0x83.  
Error code:  
0x01---Illegal function: the function code sent from host is not support by meter.  
0x02---Illegal address: the register address designated by host beyond the address range of meter.  
0x03---Illegal data: the writing data sent from host beyond the writing range of meter.  
Communication cycle:  
Communication cycle is the time from host request to client back to data: communication cycle=time of request+time of guest response+time of response delay+time of response returning. Take 9600 baud rate as example: The communication cycle of single measure data is not less than 250ms.

1. Read register  
For example: Host reads integer SV(set value 200)  
The ADD code of SV is 0x2000, because SV is integer(2 byte),seizes 1 data register. The memory code of decimal integer 200 is 0x00C8  
Note: It should read DP value or ensure DP value in first to ensure the decimal point when reading data, and need to transform the reading data to get the actual value. Conversely, it should transform the data to corresponding ratio before writing the data in meter.

Host request (Read multi-register)							
1	2	3	4	5	6	7	8
Meter ADD	Function code	Start ADD High bit	Start ADD Low bit	Data byte Length high bit	Data byte Length low bit	※CRC code low bit	※CRC code high bit
0x01	0x03	0x20	0x00	0x00	0x01	0x8F	0xCA

Guest normal answer(Read multi-register)

1	2	3	4	5	6	7
Meter ADD	Function code	Data byte number	Data high bit	Data low bit	※CRC code low bit	※CRC code high bit
0x01	0x03	0x02	0x00	0x08	0xB9	0xD2

Function code abnormal answer: For example: host request ADD is 0x2011)

Guest abnormal answer(Read multi-register)				
1	2	3	4	5
Meter ADD	Function code	Error code	※CRC code low bit	※CRC code high bit
0x01	0x83	0x02	0xC0	0xF1

2. Write multi-register  
For example: Host write SV with 0x10 function setting value 150  
ADD code of SV is 0x2000, because SV is integer(2 byte),seizes 1 data register. The hexadecimal memory code of decimal integer 150 is 0x0096.

Host request (write multi-register)										
1	2	3	4	5	6	7	8	9	10	11
Meter ADD	Function code	Start ADD High bit	Start ADD Low bit	Data byte Length high bit	Data byte Length low bit	Data byte Length high bit	Data byte Length low bit	※CRC code low bit	※CRC code high bit	
0x01	0x10	0x20	0x00	0x00	0x01	0x02	0x00	0x96	0x07	0xFC

Host write SV with 0x06 function (setting value 150)

Host request (write single-register)							
1	2	3	4	5	6	7	8
Meter ADD	Function code	ADD High bit	ADD Low bit	Data high bit	Data low bit	※CRC code low bit	※CRC code high bit
0x01	0x06	0x20	0x00	0x00	0x96	0x02	0x64

Guest normal answer (write single-register)

1	2	3	4	5	6	7	8
Meter ADD	Function code	ADD High bit	ADD Low bit	Data high bit	Data low bit	※CRC code low bit	※CRC code high bit
0x01	0x06	0x20	0x00	0x00	0x96	0x02	0x64

Data location error response: (For example: Host request the ADD index is 0x200F)

Guest abnormal answer (write multi-register)

1	2	3	4	5
Meter ADD	Function code	Error code	※CRC code low bit	※CRC code high bit
0x01	0x90	0x02	0xC0	0xC1

Address Mapping Table of Meter Parameters

No.	Add(Register No.①)	Variable name	Register	R/W	Remark
1	0x2000 (48193)	Set value SV	1	R/W	
2	0x2001 (48194)	1st alarm value AL1	1	R/W	
3	0x2002 (48195)	1st alarm hysteresis HY1	1	R/W	
4	0x2003 (48196)	2nd alarm value AL2	1	R/W	
5	0x2004 (48197)	2nd alarm hysteresis HY2	1	R/W	
6	0x2005 (48198)	Display low limit FL	1	R/W	
7	0x2006 (48199)	Display high limit FH	1	R/W	
8	0x2007 (48200)	Analog output low limit BRL	1	R/W	
9	0x2008 (48201)	Analog output high limit BRH	1	R/W	
10	0x2009 (48202)	Control output low limit OLL	1	R/W	Default 1 decimal point
11	0x200A (48203)	Control output high limit OLH	1	R/W	Default 1 decimal point
12	0x200B (48204)	Overshoot limit OVS	1	R/W	
13	0x200C (48205)	Heat & Cool control dead zone DB	1	R/W	
14	0x200D (48206)	Proportional coefficient of cooling PC	1	R/W	Default 1 decimal point
15	0x200E (48207)	Translation correct PS	1	R/W	
16	0x200F (48208)	Dispaly fuzzy tracking value DTR	1	R	Engineering work without decimal point
17	0x2010 (48209)	Measure value PV	1	R	
18	0x2011 (48210)	Output percentage MV	1	R/W	0~100
19	0x2012 (48211)	Auto-Manual switch A-M	1	R/W	0:Auto; 1:Manual
20	0x2013 (48212)	Setting parameter reserve position PRS	1	R/W	
21	0x2014 (48213)	RUN/STOP Reserve Position RSS	1	R/W	
22	0x2015 (48214)	Backlight delay time BLT	1	R/W	

Reserve

23	0x2100 (48449)	1st alarm type AD1	1	R/W	
24	0x2101 (48450)	2nd alarm type AD2	1	R/W	
25	0x2102 (48451)	1st alarm extended mode AE1	1	R/W	
26	0x2103 (48452)	2nd alarm extended mode AE2	1	R/W	
27	0x2104 (48453)	Control type OT	1	R/W	
28	0x2105 (48454)	Output type ACT	1	R/W	
29	0x2106 (48455)	RUN STOP operation	1	R/W	1:RUN 2:STP 3:Run auto-tune 4:Stop auto-tune
30	0x2107 (48456)	Decimal point DP	1	R/W	
31	0x2108 (48457)	Unit display UT	1	R/W	25(°C) 26(°F) 27( )
32	0x2109 (48458)	Filter constants FT	1	R/W	
33	0x210A (48459)	Proportional coefficient P	1	R/W	No decimal point
34	0x210B (48460)	Integral time I	1	R/W	No decimal point
35	0x210C (48461)	Differential time D	1	R/W	No decimal point
36	0x210D (48462)	Control speed fine-tune SPD	1	R/W	
37	0x210E (48463)	Heating control cycle CP	1	R/W	No decimal point
38	0x210F (48464)	Cooling control cycle CP1	1	R/W	No decimal point
39	0x2110 (48465)	Cooling relay time PT	1	R/W	No decimal point
40	0x2111 (48466)	Optional input signal INP	1	R/W	Refer to signal table
41	0x2112 (48467)	Meter address ADD	1	R/W	
42	0x2113 (48468)	Communication baud rate BAD	1	R	
43	0x2114 (48469)	Communication delay setting DTC	1	R	Note ③
44	0x2115 (48470)	PID arithmetic type PDC	1	R	
45	0x2116 (48471)	Lock key LCK	1	R	
46	0x2117 (48472)	Meter name	1	R	
47	0x2118 (48473)	Output state	1	R	Note ②
48	0x2119 (48474)	Parity Check PRTY	1	R	

R: Read only; R/W: Read & write  
Note①: The register number is the address converted to decimal plus 1 and then the register identification code 4 is added in front; for example: the register number of the data address 0x2000 is 8192 + 1 = 8193 and then 4 is added in front, that is, the register number 48193; Related applications can be seen, such as Siemens S7-200 PLC.  
Note ②: Measurement status indication. When the data bit is 1, it means execution, and when it is 0, it means no execution.

D7	D6	D5	D4	D3	D2	D1	D0
STOP	HHHH	LLLL	AT	AL2	AL1	OUT2	OUT1

Note③: DTC communication data transmission sequence and response delay description  
DTC: □ □ □ □ Reserve  
Byte transfer order: when it is 0, 1, 2, and when it is 1, 2, 1 Reserve

```

  ※ 16-bit CRC check code to get C program
  unsigned int Get_CRC(uchar *pBuf, uchar num)
  {
    unsigned ij;
    unsigned int wCrc = 0xFFFF;
    for(i=0; i<num; i++)
    {
      wCrc ^= (unsigned int)(pBuf[i]);
      for(j=0; j<8; j++)
      {
        if(wCrc & 1){wCrc >>= 1; wCrc ^= 0xA001;}
        else wCrc >>= 1;
      }
    }
    return wCrc;
  }

```